



563-391-7700

***Tube, Pipe & Profile
BENDING & METALWORKING
MACHINERY***



PEDRAZZOLI

***High-speed Electric Benders,
End Forming Machines,
Circular Saws and Band Saws***



Manufacturer of
Tube, Pipe and Profile
Bending and Metalworking Machinery



Welcome to CML USA, Inc., North American supplier of Ercolina® and Pedrazzoli®.

We are pleased to offer our customers the highest quality tube and pipe benders and related metal fabrication equipment available today. CML USA's affordable tubing benders and fabricating machinery are designed to reliably and accurately produce your applications – increasing profit, improving product quality and finish.

Our expanded product line includes more manual, automatic and CNC pipe and tube bending machines, mandrel benders, swaging and flaring equipment and metalforming machinery. Pedrazzoli high-speed mandrel benders, end forming machines, circular saws and band saws improve productivity and quality.

CML USA's experienced sales, service and support staff is always ready to offer productive application solutions for today's fabricator.

Company Profile:

CML USA, Inc. consistently leads the industry providing quality metal fabricating equipment to commercial and professional metal fabricators in the United States, Canada, Mexico and South America. Ercolina is recognized worldwide as one of the largest and most respected manufacturers of tube and pipe benders and metal fabricating machines.



We invite you to tour our websites or contact our trained knowledgeable product support representatives today at (563) 391-7700 to discuss your next bending application and arrange a demonstration of CML USA products.



info@ercolina-usa.com

ROTARY DRAW BENDERS

ROTARY DRAW BENDERS

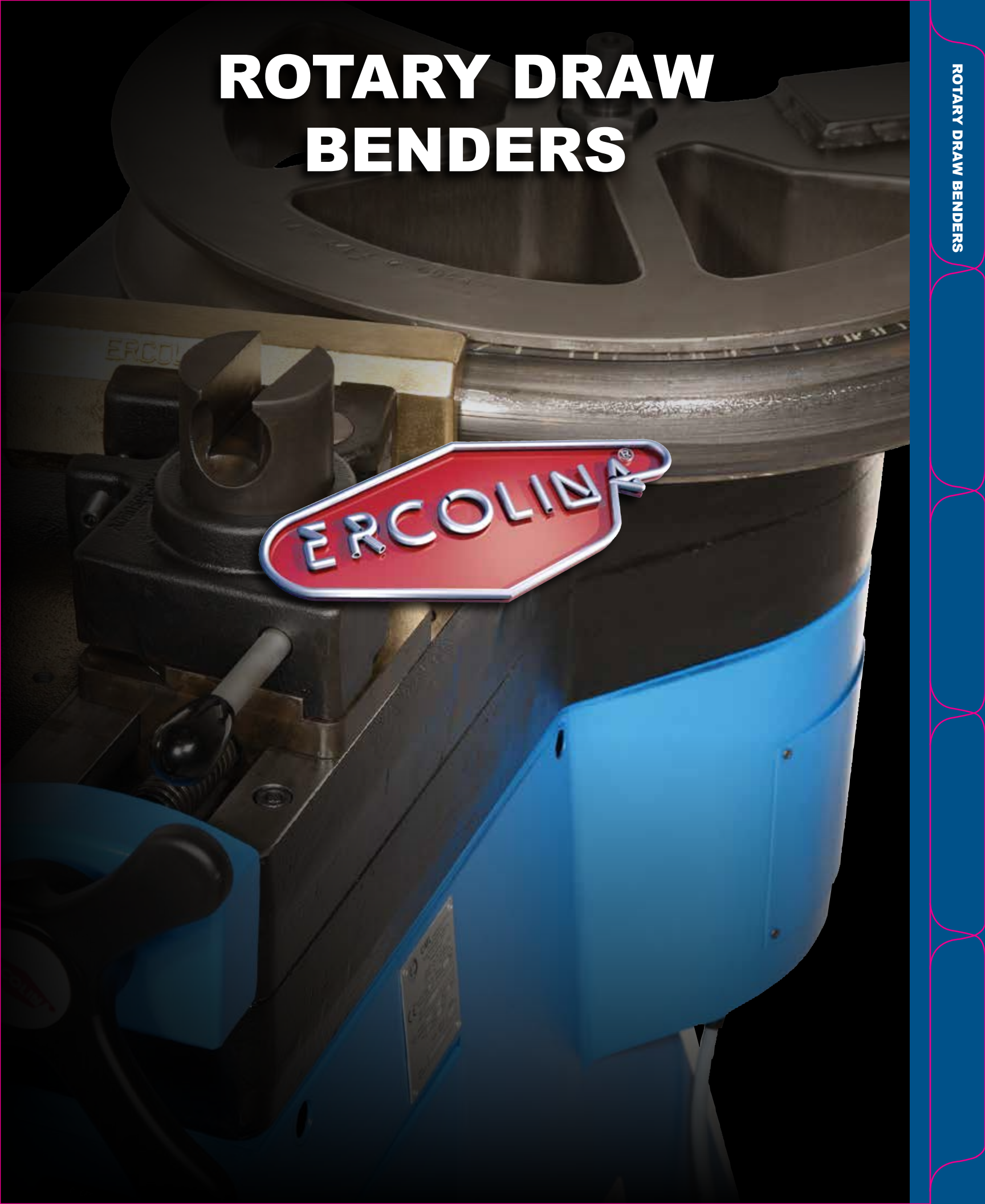

Rotary Draw Benders Table of Contents

• SB48 Super Bender	2-3
• TB60 Top Bender	4-5
• TB80 Top Bender	6-7
• TB100 Top Bender	8-9
• TB130 Top Bender	10-11
• TB180 Top Bender	12-13
• Bend formula & terminology	14
• Rotary draw bend reference info	14
• Steel & polymer pipe counterbending dies.....	15
• Pipe tooling kits	16
• Tube tooling kits	17
• Commercial pipe and wall thickness	18
• Pipe & tube information	19
• Tooling for pipe	20-21
• Tooling for round tube.....	22-23
• Tooling for square tube.....	24-25
• Round tube information.....	26
• Steel & Polymer Tube Counterbending Dies.....	26
• Rotary draw accessories	27-28
• Model selection chart	29
• A40/P two axis positioner	30
• Bending software.....	31
• Handrail Simulation Samples	32



ROTARY DRAW BENDERS

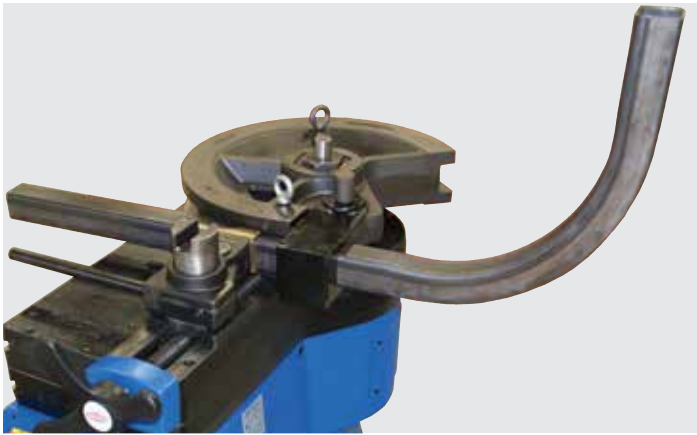



SB48 Super Bender®

Tube & Pipe Bending Machine



Part# SB48 machine only



Additional Savings when Purchasing Tooling Kit with Machine

SB48 with Pipe Kit Part# SB48P

Pipe Size	CLR	Min. Wall	Center Former Part #	Counterbend Die Part #
½"	1.8	.109	153R046P0500	155P0500
¾"	2.2	.113	153R056P0750	155P0750
1"	2.6	.133	153R067P1000	155P1000
1¼"	3.5	.140	153R090P1250	155P1250
1½"	3.9	.145	153R100P1500	155P1500

Pipe Kit only Part# PIPEKIT2

SB48 with "Small Radius" Tube Kit Part# SB48TSR

Tube Size	CLR	Min. Wall	Center Former Part #	Counterbend Die Part #
¾"	2.6	.035	153R067T0750	154T0750
7/8"	2.2	.065	153R056T0875	154T0875
1"	2.6	.065	153R067T1000	154T1000
1¼"	3.2	.083	153R082T1250	154T1250
1½"	3.9	.083	153R100T1500	154T1500

"Small Radius" Tube Kit only Part# TUBEKIT2SR

SB48 with "Large Radius" Tube Kit Part# SB48T

Tube Size	CLR	Min. Wall	Center Former Part#	Counterbend Die Part#
¾"	2.6	.035	153R067T0750	154T0750
7/8"	2.6	.035	153R067T0875	154T0875
1"	3.2	.035	153R082T1000	154T1000
1¼"	4.4	.035	153R112T1250	154T1250
1½"	5.9	.049	153R150T1500	154T1500
1¾"	6.7	.065	153R170T1750	154T1750

"Large Radius" Tube Kit only Part# TUBEKIT2

Store Multiple Bend Angles and Programs

FEATURES

- Ideal for producing consistent quality bends in pipe, tube, squares, solids and other profiles
- Touch screen programming of bend angle with system diagnostics in multiple languages
- Touch screen indicates digital display of bend angle, springback and bend speed for each bend within the program
- Bend any angle to 180° with independent material springback compensation for each bend
- Quick-change tooling system with multiple radii available
- Swing away counterbending die vise for easy material handling
- Automatically stops at desired bend angle to end cycle
- Use control panel or foot pedal to initiate bend and return functions
- Counterbending die position monitored electronically for accuracy and repeatability
- No hydraulic components

SB48 Capacities & Specifications

6/16

Tube (Min.)	1/4"
(Max.)	2"
Pipe (Max.)	1 1/2" Sch. 40
Centerline Radius (Min.)	2 x Ø
(Max.)	8 7/8"
Degree of Bend	0-210°
Bending Speed	Fixed speed
Programming	Touch screen Program storage Multiple bends per program
Material Positioning Table	Available (see page 30)
Voltage	110V Single Phase
Length, Width, Height	22 1/2" x 16 1/4" x 39 1/2"
Weight	300 lbs.

All capacities based on A53 grade A 48,000 psi tensile materials; heavy wall and high tensile materials reduce machine capacity. Consult supplier for material specifications.



Tube & Pipe Tooling Kits



Spray Lubricant



Two Axis Positioner



Easy Part Layout Software



Square Tooling

Tooling Kits [Pages 16-17](#)

Tooling and Accessories [Pages 20-28](#)

Model Selection Chart [Page 29](#)

- Accepts Ercolina's A40-P two axis positioning table for multiple and sequential bends
- Classic Ercolina Super Bender design reduces space requirement and stores easily to save shop floor space

Product Demonstrations Available on Website

**NEED ADDITIONAL HELP?
CONTACT ERCOLINA:**

563.391.7700

info@ercolina-usa.com



TB60 Top Bender[®]

Tube & Pipe Bending Machine



Part# TB60
machine only



Additional Savings when Purchasing Tooling Kit with Machine

TB60 with Pipe Kit • Part# TB60P

Pipe Size	CLR	Min. Wall	Center Former Part #	Counterbend Die Part #
1/2"	1.8	.109	153R046P0500	155P0500
3/4"	2.2	.113	153R056P0750	155P0750
1"	2.6	.133	153R067P1000	155P1000
1 1/4"	3.5	.140	153R090P1250	155P1250
1 1/2"	3.9	.145	153R100P1500	155P1500
2"	5.9	.109	153R150P2000	155P2000

Pipe Kit only Part# PIPEKIT1

TB60 with "Small Radius" Tube Kit Part# TB60TSR

Tube Size	CLR	Min. Wall	Center Former Part #	Counterbend Die Part #
3/4"	2.6	.035	153R067T0750	154T0750
7/8"	2.2	.065	153R056T0875	154T0875
1"	2.6	.065	153R067T1000	154T1000
1 1/4"	3.2	.083	153R082T1250	154T1250
1 1/2"	3.9	.083	153R100T1500	154T1500
2"	5.9	.095	153R150T2000	154T2000

"Small Radius" Tube Kit only Part# TUBEKIT1SR

TB60 with "Large Radius" Tube Kit Part# TB60T

Tube Size	CLR	Min. Wall	Center Former Part#	Counterbend Die Part#
3/4"	2.6	.035	153R067T0750	154T0750
7/8"	2.6	.035	153R067T0875	154T0875
1"	3.2	.035	153R082T1000	154T1000
1 1/4"	4.4	.035	153R112T1250	154T1250
1 1/2"	5.9	.049	153R150T1500	154T1500
1 3/4"	6.7	.065	153R170T1750	154T1750
2"	7.5	.065	153R190T2000	154T2000

"Large Radius" Tube Kit only Part# TUBEKIT1

Ercolina's Most Popular Workhorse

FEATURES

- Ideal for producing consistent quality bends in pipe, tube, squares, solids and other profiles
- Touch screen programming of bend angle with system diagnostics in multiple languages
- Touch screen indicates digital display of bend angle, springback and bend speed for each bend within the program
- Bend any angle to 180° with independent material springback compensation for each bend
- Quick-change tooling system with multiple radii available
- Swing away counterbending die vise for easy material handling
- Automatically stops at desired bend angle to end cycle
- Use control panel or foot pedal to initiate bend and return functions
- Counterbending die position monitored electronically for accuracy and repeatability
- No hydraulic components
- Accepts Ercolina's A40-P two axis positioning table

TB60 Capacities & Specifications

10/12

Tube (Min.)	1/4"
(Max.)	2 1/2"
Pipe (Max.)	2" Sch. 40
Centerline Radius (Min.)	2 x Ø
(Max.)	15"
Degree of Bend	0-210°
Bending Speed	Variable
Programming	Touch screen Program storage Multiple bends per program
Material Positioning Table	Available (see page 30)
Voltage	220V or 480V 3ph (220V Single Phase available)
Length, Width, Height	27" x 15" x 36"
Weight	430 lbs.

All capacities based on A53 grade A 48,000 psi tensile materials; heavy wall and high tensile materials reduce machine capacity. Consult supplier for material specifications.



Tube & Pipe Tooling Kits



Spray Lubricant



Two Axis Positioner



Easy Part Layout Software

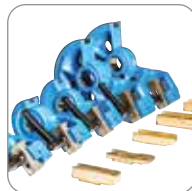

Square Tooling

Tooling Kits [Pages 16-17](#)

Tooling and Accessories [Pages 20-28](#)

Model Selection Chart [Page 29](#)

for multiple and sequential bends

- Classic Ercolina Top Bender design reduces floor space requirement and stores easily to save shop floor space

Product Demonstrations Available on Website

**NEED ADDITIONAL HELP?
CONTACT ERCOLINA:**

563.391.7700

info@ercolina-usa.com



TB80 Top Bender®

Tube & Pipe Bending Machine



Part# TB80-4 machine only

Additional Savings when Purchasing Tooling Kit with Machine

TB80-4 (480V 3ph) with Pipe Kit • Part# TB80-4P
TB80 (220V 3ph) with Pipe Kit • Part# TB80P

Pipe Size	CLR	Min. Wall	Center Former Part #	Counterbend Die Part #
1"	2.6	.133	153R067P1000	155P1000
1¼"	3.5	.140	153R090P1250	155P1250
1½"	3.9	.145	153R100P1500	155P1500
2"	5.9	.109	153R150P2000	155P2000
2½"	10.2	.203	157R260P2500-80	155P2500

Pipe Kit only Part# PIPEKIT6

TB80-4 (480V 3ph) with "Large Radius" Tube Kit
Part# TB80-4TLR

TB80 (220V 3ph) with "Large Radius" Tube Kit
Part# TB80TLR

Tube Size	CLR	Min. Wall	Center Former Part#	Counterbend Die Part#
1"	3.2	.035	153R082T1000	154T1000
1¼"	4.4	.035	153R112T1250	154T1250
1½"	5.9	.049	153R150T1500	154T1500
1¾"	6.7	.065	153R170T1750	154T1750
2"	7.5	.065	153R190T2000	154T2000

"Large Radius" Tube Kit only Part# TUBEKIT5

Auto Load Sensing Improves Torque

FEATURES

- Ideal for producing consistent quality bends in large pipe, tube, squares, solids and other profiles with auto tune
- Touch screen control icon menu for easy access to auto and manual operating modes, programming (inch or metric), system diagnostics and multiple language capability
- Quick-change tooling system with multiple radii available
- Digital display of bend angle and bend speed
- Bend any angle to 180° with independent material springback and speed compensation for each bend
- Foot pedal control of bend and return functions
- Swing away counterbending die vise for easy material handling
- Counterbending die vise position monitored electronically for accuracy and repeatability
- Heavy-duty steel gear case, right or left bend capable
- No hydraulic components for quiet operation
- Mandrel ready with optional accessory
- Two axis positioning table for multiple and sequential bends available on special request
- On screen machine diagnostics

TB80 Capacities & Specifications

20/12

Tube (Min.)	1/4"
(Max.)	3" (.120 wall)
Pipe (Max.)	2 1/2" Sch. 40 Grade B A53
Centerline Radius (Min.)	2 x Ø (3" CLR with standard tooling)
(Max.)	16.5"
Degree of Bend	0-210°
Bending Speed	Variable 1.5 to 3 RPM
Programming	Touch screen - 7" Unlimited storage with USB (30) bends per program
Material Positioning Table	Consult factory
Voltage	220V or 480V 3ph
Length, Width, Height	20" x 34" x 47"
Weight	980 lbs.

All capacities based on A53 grade B 60,000 psi tensile materials; heavy wall and high tensile materials reduce machine capacity. Consult supplier for material specifications.

POPULAR ACCESSORIES



Tube & Pipe Tooling Kits



Spray Lubricant



Easy Part Layout Software

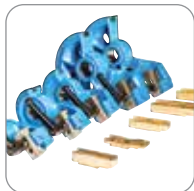

Large Square Tooling

Tooling Kits [Pages 16-17](#)

Tooling and Accessories [Pages 20-28](#)

Model Selection Chart [Page 29](#)



◀ Ercolina Bending Application

Product Demonstrations Available on Website

NEED ADDITIONAL HELP? CONTACT ERCOLINA:

563.391.7700

info@ercolina-usa.com

www.ercolina-usa.com



TB100 Top Bender[®]

Tube & Pipe Bending Machine



Part# TB100 machine only

Additional Savings when Purchasing Tooling Kit with Machine

TB100 with Pipe Kit • Part# TB100P

Pipe Size	CLR	Min. Wall	Center Former Part #	Counterbend Die Part #
1¼"	3.5	.140	153R090P1250	155P1250
1½"	3.9	.145	153R100P1500	155P1500
2"	5.9	.109	153R150P2000	155P2000
2½"	11.8	.203	157R300P2500-80	155P2500
3"	11.8	.216	157R300P3000-80	155P3000

Pipe Kit only Part# PIPEKIT4

TB100 with "Small Radius" Tube Kit Part# TB100TSR

Tube Size	CLR	Min. Wall	Center Former Part #	Counterbend Die Part #
¾"	2.6	.035	153R067T0750	154T0750
⅞"	2.2	.065	153R056T0875	154T0875
1"	2.6	.065	153R067T1000	154T1000
1¼"	3.2	.083	153R082T1250	154T1250
1½"	3.9	.083	153R100T1500	154T1500
2"	5.9	.095	153R150T2000	154T2000

"Small Radius" Tube Kit only Part# TUBEKIT1SR

TB100 with "Large Radius" Tube Kit Part# TB100TLR

Tube Size	CLR	Min. Wall	Center Former Part#	Counterbend Die Part#
¾"	2.6	.035	153R067T0750	154T0750
⅞"	2.6	.035	153R067T0875	154T0875
1"	3.2	.035	153R082T1000	154T1000
1¼"	4.4	.035	153R112T1250	154T1250
1½"	5.9	.049	153R150T1500	154T1500
1¾"	6.7	.065	153R170T1750	154T1750
2"	7.5	.065	153R190T2000	154T2000

"Large Radius" Tube Kit only Part# TUBEKIT1

Accurately Bend Heavy Profiles

FEATURES

- Ideal for producing consistent quality bends in large pipe, tube, squares, solids and other profiles
- Touch screen control offers easy access to auto and manual operating modes, programming (inch or metric), system diagnostics and multiple language capability
- Quick-change tooling system with multiple radii available
- Digital display of bend angle
- Bend any angle to 180° with independent material springback compensation for each bend
- Foot pedal control of bend and return functions
- Swing away counterbending die vise for easy material handling
- Counterbending die vise position monitored electronically for accuracy and repeatability
- Two axis positioning table for multiple and sequential bends available on special request
- Heavy-duty steel gear case
- No hydraulic components

TB100 Capacities & Specifications

42/16

Tube (Min.)	1/4"
(Max.)	4"
Pipe (Max.)	3" Sch. 40
Centerline Radius (Min.)	2 x Ø
(Max.)	17"
Degree of Bend	0-210°
Bending Speed	Variable to 1.3 RPM
Programming	Touch screen Unlimited storage with USB (12) bends per program
Material Positioning Table	Consult factory
Voltage	220V or 480V 3ph
Length, Width, Height	20" x 34" x 47"
Weight	1,030 lbs.

All capacities based on A53 grade A 48,000 psi tensile materials; heavy wall and high tensile materials reduce machine capacity.
Consult supplier for material specifications.

POPULAR ACCESSORIES



Tube & Pipe Tooling Kits



Spray Lubricant



Easy Part Layout Software



Roller Counterbending Die

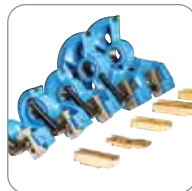

Large Square Tooling

Tooling Kits [Pages 16-17](#)

Tooling and
Accessories [Pages 20-28](#)

Model Selection
Chart [Page 29](#)



◀ Ercolina Bending Application

**Product
Demonstrations
Available on Website**

**NEED ADDITIONAL HELP?
CONTACT ERCOLINA:**

563.391.7700

info@ercolina-usa.com



TB130 Top Bender®

Tube & Pipe Bending Machine



Part# TB130 machine only



Additional Savings when Purchasing Tooling Kit with Machine

TB130 with Pipe Kit • Part# TB130P

Pipe Size	CLR	Min. Wall	Center Former Part #	Counterbend Die Part #
1¼"	3.5	.140	153R090P1250	155P1250
1½"	3.9	.145	153R100P1500	155P1500
2"	5.9	.109	153R150P2000	155P2000
2½"	11.8	.203	157R300P2500-80	155P2500
3"	11.8	.216	157R300P3000-80	155P3000

Pipe Kit only Part# PIPEKIT4

TB130 with "Small Radius" Tube Kit Part# TB130TSR

Tube Size	CLR	Min. Wall	Center Former Part #	Counterbend Die Part #
¾"	2.6	.035	153R067T0750	154T0750
⅞"	2.2	.065	153R056T0875	154T0875
1"	2.6	.065	153R067T1000	154T1000
1¼"	3.2	.083	153R082T1250	154T1250
1½"	3.9	.083	153R100T1500	154T1500
2"	5.9	.095	153R150T2000	154T2000

"Small Radius" Tube Kit only Part# TUBEKIT1SR

TB130 with "Large Radius" Tube Kit Part# TB130TLR

Tube Size	CLR	Min. Wall	Center Former Part #	Counterbend Die Part #
¾"	2.6	.035	153R067T0750	154T0750
⅞"	2.6	.035	153R067T0875	154T0875
1"	3.2	.035	153R082T1000	154T1000
1¼"	4.4	.035	153R112T1250	154T1250
1½"	5.9	.049	153R150T1500	154T1500
1¾"	6.7	.065	153R170T1750	154T1750
2"	7.5	.065	153R190T2000	154T2000

"Large Radius" Tube Kit only Part# TUBEKIT1

Reliable Repeatable Bends

FEATURES

- Ideal for producing consistent quality bends in large pipe, tube, squares, solids and other profiles
- Touch screen control offers easy access to auto and manual operating modes, programming (inch or metric), system diagnostics and multiple language capability
- Quick-change tooling system with multiple radii available
- Digital display of bend angle
- Bend any angle to 180° with independent material springback compensation for each bend
- Foot pedal control of bend and return functions
- Swing away counterbending die vise for easy material handling
- Counterbending die vise position monitored electronically for accuracy and repeatability
- Two axis positioning table for multiple and sequential bends available on special request
- Heavy-duty steel gear case
- No hydraulic components

TB130 Capacities & Specifications

80/16

Tube (Min.)	1/4"
(Max.)	5"
Pipe (Max.)	4" Sch. 40
Centerline Radius (Min.)	2 x Ø
(Max.)	27 1/2"
Degree of Bend	0-210°
Bending Speed	Variable to .75 RPM
Programming	Touch screen Unlimited storage with USB (12) bends per program
Material Positioning Table	Consult factory
Voltage	220V or 480V 3ph
Length, Width, Height	34" x 34" x 47"
Weight	1,330 lbs.

All capacities based on A53 grade A 48,000 psi tensile materials; heavy wall and high tensile materials reduce machine capacity.
Consult supplier for material specifications.

POPULAR ACCESSORIES



Tube & Pipe Tooling Kits



Spray Lubricant



Easy Part Layout Software



Roller Counterbending Die

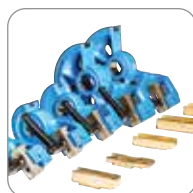

Large Square Tooling

Tooling Kits [Pages 16-17](#)

Tooling and
Accessories [Pages 20-28](#)

Model Selection
Chart [Page 29](#)



◀ Ercolina Bending Application

**Product
Demonstrations
Available on Website**

**NEED ADDITIONAL HELP?
CONTACT ERCOLINA:**

563.391.7700

info@ercolina-usa.com



TB180 Top Bender®

Tube & Pipe Bending Machine



Easy touch screen bend angle programming.



Part# TB180 machine only



Bending Power For Large Profiles!

FEATURES

- Ideal for producing consistent quality bends in large pipe, tube, squares, solids and other profiles
- Touch screen control offers easy access to auto and manual operating modes, programming (inch or metric), system diagnostics and multiple language capability
- Quick-change tooling system with multiple radii available
- Digital display of bend angle
- Bend any angle to 180° with independent material springback compensation for each bend
- Hand-held control of bend, return and emergency stop functions
- Hydraulically operated counterbending die vise to control material springback
- Swing away counterbending die vise for easy material handling
- Counterbending die vise position monitored electronically for accuracy and repeatability
- Heavy-duty steel gear case

TB180 Capacities & Specifications

180/32

Tube (Min.) (Max.)	1½" - 6.7" CLR 6" - .120 wall
Pipe (Min.) (Max.)	1" Sch. 40 - 6.7" CLR 6" Sch. 40
Centerline Radius (Min.) (Max. standard machine) (Max. machine w/case extension)	3 x Ø or 4.5" CLR 23½" 31½"
Degree of Bend	0-210°
Bending Speed	Variable to 1 RPM
Programming	Touch screen Unlimited storage with USB (12) bends per program
Material Positioning Table	Not available
Voltage	480V 3ph
Length, Width, Height	75" x 40" x 59"
Weight	6,000 lbs.

All capacities based on A53 grade A 48,000 psi tensile materials; heavy wall and high tensile materials reduce machine capacity. Consult supplier for material specifications.

TOOLING

Pipe and Tube Tooling Available in 3D and 5D Centerline Radius Quoted on Request

May Require Additional Mounting Component

Tooling and Accessories Pages [15-28](#)

Model Selection Chart [Page 29](#)

POPULAR ACCESSORIES



Roller Counterbending Die



Spray Lubricant



Easy Part Layout Software



◀ Ercolina Bending Application

Product Demonstrations Available on Website

NEED ADDITIONAL HELP? CONTACT ERCOLINA:

563.391.7700

info@ercolina-usa.com



Bend Formula & Terminology

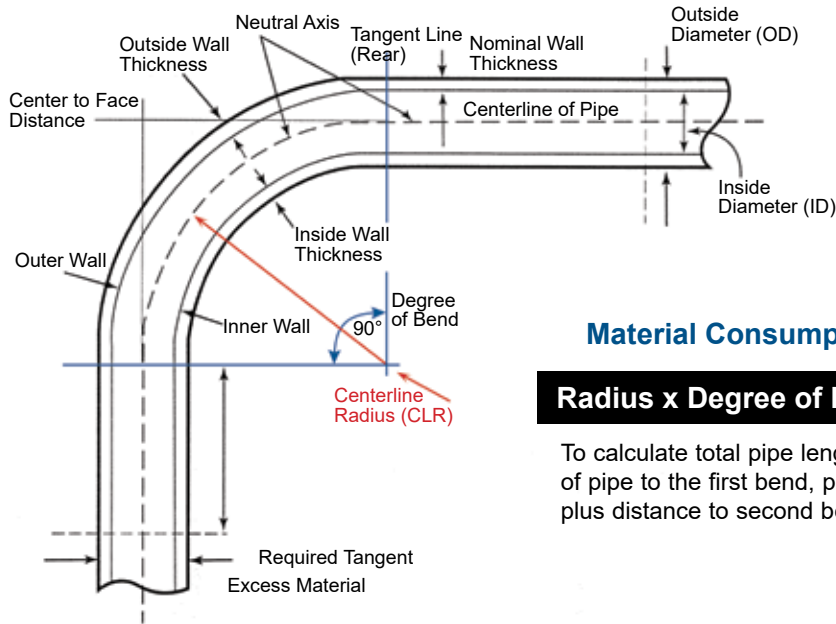

Material Consumption for Bend Angle

$$\text{Radius} \times \text{Degree of Bend} \times .0175 = \text{Length}$$

To calculate total pipe length, add distance from end of pipe to the first bend, plus first bend arc length, plus distance to second bend.

Rotary Draw Bend Reference Information

The following information should be used as a guideline only, exact material consumption may vary.

Material Required for Rotary Draw Bends in Pipe

Angle of Bend	Pipe Size and Centerline Radius					
	1/2"	3/4"	1"	1 1/4"	1 1/2"	2"
	1.8	2.2	2.6	3.5	3.9	5.9
	Material Consumption Guideline					
15	.47	.58	.68	.92	1.0	1.5
30	.97	1.1	1.3	1.8	2.0	3.1
45	1.4	1.7	2.0	2.7	3.0	4.6
60	1.8	2.3	2.7	3.6	4.0	6.2
75	2.3	2.8	3.4	4.5	5.1	7.7
90	2.8	3.4	4.0	5.5	6.1	9.3
120	3.7	4.6	5.4	7.3	8.1	12.4
140	4.4	5.3	6.3	8.5	9.5	14.5
160	5.0	6.1	7.2	9.7	10.8	16.5
180	5.6	6.9	8.1	11.0	12.2	18.6

Minimum Distance Between Bends for Standard Non-Mandrel Tooling

Former Radius Inches	Former Radius Millimeters	Min. Distance Between Bends
1.8	46	3.1
2.2	56	3.7
2.6	67	3.9
3.2	82	3.9
3.5	90	4.3
3.9	100	4.3
4.1	105	4.3
4.4	112	4.3
4.7	120	5.5
5.1	130	5.5
5.9	150	5.9
6.7	170	5.9
7.5	190	5.9
8.9	225	5.9
10.2	260	6.2
11.8	300	6.2

Consult factory for special tooling request.



Pipe dimensions are based on I.D. of material
(2" sch. 40 pipe measures 2.375" O.D.).

Steel & Polymer Pipe Counterbending Dies

STEEL

Pipe Size	Outside Diameter	Counterbend Die Part#
3/8"	.675	155AP0375
1/2"	.840	155AP0500
3/4"	1.050	155AP0750
1"	1.315	155AP1000
1 1/4"	1.660	155AP1250
1 1/2"	1.900	155AP1500
2"	2.375	155AP2000

Steel used for heavy wall or abrasive application.

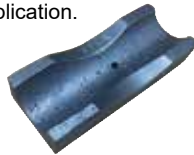

Consult factory for
tooling sizes not shown.

STEEL SUPPORT WITH REPLACEABLE POLYMER INSERT

Pipe Size	Outside Diameter	Counterbend Die Part#
1"	1.315	155SP1000
1 1/4"	1.660	155SP1250
1 1/2"	1.900	155SP1500
2"	2.375	155SP2000

Polymer recommended for materials with a polished finish such as stainless and aluminum.



REPLACEABLE POLYMER INSERTS

1"	1.315	155SP1000INS
1 1/4"	1.660	155SP1250INS
1 1/2"	1.900	155SP1500INS
2"	2.375	155SP2000INS



Save with Pipe Tooling Kits

(Additional Savings when Purchased with Machine)

Description	Material Size	Centerline Radius - Inches -	Min. Wall	Center Former Part#	Counterbend Die Part#	Available with Ercolina Machines
PIPEKIT1	1/2"	1.8	.109	153R046P0500	155P0500	TB60, 030 Mega Bender, TB80
	3/4"	2.2	.113	153R056P0750	155P0750	
	1"	2.6	.133	153R067P1000	155P1000	
	1 1/4"	3.5	.140	153R090P1250	155P1250	
	1 1/2"	3.9	.145	153R100P1500	155P1500	
	2"	5.9	.109	153R150P2000	155P2000	
PIPEKIT2	1/2"	1.8	.109	153R046P0500	155P0500	SB48
	3/4"	2.2	.113	153R056P0750	155P0750	
	1"	2.6	.133	153R067P1000	155P1000	
	1 1/4"	3.5	.140	153R090P1250	155P1250	
	1 1/2"	3.9	.145	153R100P1500	155P1500	
Handrail Pipe Kit HRPIPEKIT	1 1/4"	3.5	.140	153R090P1250	155P1250	SB48, TB60, 030 Mega Bender, TB80
	1 1/2"	3.9	.145	153R100P1500	155P1500	
PIPEKIT4	1 1/4"	3.5	.140	153R090P1250	155P1250	TB100, TB130
	1 1/2"	3.9	.145	153R100P1500	155P1500	
	2"	5.9	.109	153R150P2000	155P2000	
	2 1/2"	11.8	.203	157R300P2500-80	155P2500	
	3"	11.8	.216	157R300P3000-80	155P3000	
PIPEKIT6	1"	2.6	.133	153R067P1000	155P1000	TB80
	1 1/4"	3.5	.140	153R090P1250	155P1250	
	1 1/2"	3.9	.145	153R100P1500	155P1500	
	2"	5.9	.109	153R150P2000	155P2000	
	2 1/2"	10.2	.203	157R260P2500-80	155P2500	

Refer to machine specifications for individual capacities.

All tooling is manufactured for mild steel general tube and pipe dimensions. Tooling groove is slightly under-size designed to better form tube shape throughout bend.

Tooling can be modified to customer's required dimensions and or polished at additional cost to improve finish. Contact Ercolina customer service for additional information at (563) 391-7700.

Save with Tube Tooling Kits

(Additional Savings when Purchased with Machine)

Description	Material Size	Centerline Radius - Inches -	Min. Wall	Center Former Part#	Counterbend Die Part#	Available with Ercolina Machines
Small Radius Tube Kit TUBEKIT1SR	¾"	2.6	.035	153R067T0750	155T0750	TB60, 030 Mega Bender, TB80, TB100, TB130
	⅞"	2.2	.065	153R056T0875	154T0875	
	1"	2.6	.065	153R067T1000	154T1000	
	1¼"	3.2	.083	153R082T1250	154T1250	
	1½"	3.9	.083	153R100T1500	154T1500	
	2"	5.9	.095	153R150T2000	154T2000	
Small Radius Tube Kit TUBEKIT2SR	¾"	2.6	.035	153R067T0750	154T0750	SB48
	⅞"	2.2	.065	153R056T0875	154T0875	
	1"	2.6	.065	153R067T1000	154T1000	
	1¼"	3.2	.083	153R082T1250	154T1250	
	1½"	3.9	.083	153R100T1500	154T1500	
Large Radius Tube Kit TUBEKIT1	¾"	2.6	.035	153R067T0750	154T0750	TB60, 030 Mega Bender, TB100, TB130
	⅞"	2.6	.035	153R067T0875	154T0875	
	1"	3.2	.035	153R082T1000	154T1000	
	1¼"	4.4	.035	153R112T1250	154T1250	
	1½"	5.9	.049	153R150T1500	154T1500	
	1¾"	6.7	.065	153R170T1750	154T1750	
	2"	7.5	.065	153R190T2000	154T2000	
Large Radius Tube Kit TUBEKIT2	¾"	2.6	.035	153R067T0750	154T0750	SB48
	⅞"	2.6	.035	153R067T0875	154T0875	
	1"	3.2	.035	153R082T1000	154T1000	
	1¼"	4.4	.035	153R112T1250	154T1250	
	1½"	5.9	.049	153R150T1500	154T1500	
	1¾"	6.7	.065	153R170T1750	154T1750	
Large Radius Tube Kit TUBEKIT5	1"	3.2	.035	153R082T1000	154T1000	TB80
	1¼"	4.4	.035	153R112T1250	154T1250	
	1½"	5.9	.049	153R150T1500	154T1500	
	1¾"	6.7	.065	153R170T1750	154T1750	
	2"	7.5	.065	153R190T2000	154T2000	

Refer to machine specifications for individual capacities.

All tooling is manufactured for mild steel general tube and pipe dimensions. Tooling groove is slightly undersize designed to better form tube shape throughout bend.

Tooling can be modified to customer's required dimensions and or polished at additional cost to improve finish. Contact Ercolina customer service for additional information at (563) 391-7700.



Commercial Pipe and Wall Thickness

Nominal Pipe Size	Outside Diameter	Schedule 5	Schedule 10	Schedule 40	Schedule 80	Schedule 160	Schedule XXS
6.35mm 1/4"	13.7mm 0.540"	1.20 0.049	1.72 0.065	2.24 0.088	3.02 0.119		
9.52mm 3/8"	17.1mm 0.675"	1.20 0.049	1.72 0.065	2.31 0.091	3.20 0.126		
12.7mm 1/2"	21.3mm 0.840"	1.72 0.065	2.11 0.083	2.77 0.109	3.73 0.147	4.78 0.187	7.47 0.294
19.1mm 3/4"	26.7mm 1.050"	1.72 0.065	2.11 0.083	2.87 0.113	3.91 0.154	5.54 0.218	7.82 0.308
25.4mm 1"	33.4mm 1.315"	1.72 0.065	2.77 0.109	3.38 0.133	4.55 0.179	6.35 0.250	9.09 0.358
31.8mm 1-1/4"	42.2mm 1.660"	1.72 0.065	2.77 0.109	3.56 0.140	4.85 0.191	6.35 0.250	9.70 0.382
38.1mm 1-1/2"	48.3mm 1.900"	1.72 0.065	2.77 1.109	3.68 0.145	5.08 0.200	7.10 0.281	10.16 0.400
50.8mm 2"	60.3mm 2.375"	1.72 0.065	2.77 0.109	3.91 0.154	5.54 0.218	8.74 0.343	11.07 0.436
63.5mm 2-1/2"	73.0mm 2.875"	2.11 0.083	3.04 0.120	5.16 0.203	7.01 0.276	9.52 0.375	14.02 0.552
76.1mm 3"	88.9mm 3.500"	2.11 0.083	3.04 0.120	5.49 0.216	7.62 0.300	11.13 0.438	15.24 0.600
88.9mm 3-1/2"	101.6mm 4.000"	2.11 0.083	3.04 0.120	5.70 0.226	8.10 0.318		15.91 0.636
101.6mm 4"	114.3mm 4.500"	2.11 0.083	3.04 0.120	6.02 0.237	8.56 0.337	13.49 0.531	17.12 0.674
127.0mm 5"	141.3mm 5.563"	2.77 0.109	3.38 0.134	6.55 0.258	9.52 0.375	15.88 0.625	19.1 0.750
152.4mm 6"	168.3mm 6.625"	2.77 0.109	3.38 0.134	7.11 0.280	10.97 0.432	18.26 0.718	21.95 0.864

Information required for rotary draw tooling applications

- Size and wall thickness of material
- Material type and grade
- Number of bends on part
- Distance between bends
- Plane of bend relationship to one another
- Production rates
- Part tolerances
- Centerline radius of the bends. **Note:** bends with radius less than 2 times OD require greater attention, high grade bendable materials and heavier machine design.

Understanding material to be bent

Bending application success is dependent on several factors including and most importantly the proper material. Obtain a print of work to be done, review dimensions and tolerances. Review the mill certification for material from the mill and confirm the material is appropriate for bending. Use caliper to measure material and confirm dimensions are correct for tooling. Tube OD and wall thickness variations are far more common than you may realize. For some tube fabricating applications, this variation is of little concern, but in rotary draw bending, ID dimension variation is a big issue. The tubing must fit the tooling correctly and have the appropriate clearances.

Note: different types of material can be bent i.e., steel, aluminum, and stainless however the tooling composition and CLR may change to ensure material compatibility. Pay attention to material ordered and confirm it's received as ordered.

Terminology

Bend Specifications

OD is tube outside diameter, usually measured in inches or millimeters. Sometimes the tube outside diameter is expressed in nominal, such as IPS for pipe. Only rarely is a tube diameter specified as an inside diameter. This is non-standard, leads to confusion, and should be avoided. Whatever units are used, OD should be expressed in decimal, to three places in the case of inches.

WT is wall thickness. Inches and millimeters are common units, and again the precision of a decimal number to three places is warranted if inches are used; at least one place for millimeters. Frequently, the old Birmingham Wire Gage Standard is used to express WT; be sure to use the correct gage (there are several standards) when translating to decimal inches. When the Tube OD is expressed as an IPS nominal size, then the WT is expressed as a schedule number, which corresponds to a precise value in inches.

CLR is centerline radius and is the most common reference for bend radius. Again, inches and millimeters are the common units of measurement. Typically, fractional or two-place decimal inches are sufficiently precise. Sometimes the CLR is expressed as a multiple of the Tube OD, such as "1-D", "2-D", and so on. Note that if the Tube OD is expressed as an IPS nominal size and the CLR is expressed as a "D", it is a multiple of the nominal, not the actual tube diameter. Inside radius, abbreviated "ISR", is a common reference for specifying bend radius if the tubing is non-round. Outside radius is seldom used to define the bend radius.

DOB is degree of bend, often loosely referred to as the sweep of bend or depth of bend. This defines in decimal degrees (occasionally degrees and minutes) the arc of the bend. This is, of course, different from "plane of bend" or "orientation", a specification for multi-bend parts which defines in degrees where the plane of the current bend is located relative to the plane of the first bend.

In defining multi-bend parts, XYZ rectangular coordinates are used, from which bend data are developed. Bend data consist of tangent length, plane of bend, and degree of bend and defines the motion of the tube during the bending process.



Tooling for Pipe

Pipe Size	Outside Diameter	Wall Thickness Sch. / Inch	Min. CLR Inch	Drive Diameter	Center Former Part#	Counterbend Die Part#
1/4"	.540	40 - .088	1.4		153R036P0250	155P0250
3/8"	.675	40 - .091	1.4		153R036P0375	155P0375
		10 - .065	2.2	153R056P0375		
1/2"	.840	40 - .109	1.8	40mm	153R046P0500 ●	155P0500
		10 - .083	2.2		153R056P0500	
		5 - .065	2.6		153R067P0500	
		5 - .065	4.4		156R112P0500	
3/4"	1.050	40 - .113	2.2	50mm	153R056P0750 ●	155P0750
		10 - .083	2.6		153R067P0750	
		5 - .065	3.2		153R082P0750	
		5 - .065	5.1		156R130P0750	
1"	1.315	40 - .133	2.6	40mm	153R067P1000 ●	155P1000
		10 - .109	3.2	40mm	153R082P1000	
		10 - .109	3.9	50mm	156R100P1000	
		5 - .065	4.4	40mm	153R112P1000	
		5 - .065	6.7	50mm	156R170P1000	
		5 - .065	6.7	110mm	157R170P1000-110	
1 1/4"	1.660	40 - .140	3.5	50mm	153R090P1250 ●	155P1250
		40 - .140	3.9		153R100P1250	
		10 - .109	5.1		153R130P1250	
		5 - .065	5.9		153R150P1250	
		5 - .065	7.5		153R190P1250	
		5 - .065	8.9		157R225P1250	
		5 - .065	8.9	110mm	157R225P1250-110	
1 1/2"	1.900	40 - .145	3.9	50mm	153R100P1500 ●	155P1500
		40 - .145	5.1		153R130P1500	
		40 - .145	5.9		153R150P1500	
		10 - .109	6.7		153R170P1500	
		5 - .065	7.5		153R190P1500	
		5 - .065	9.8		157R250P1500	
		5 - .065	9.8		110mm	

Tooling for Pipe

- Continued from previous page -

Pipe Size	Outside Diameter	Wall Thickness Sch. / Inch	Min. CLR Inch	Drive Diameter	Center Former Part#	Counterbend Die Part#
2"	2.375	40 - .154	5.1	50mm	153R130P2000	155P2000
		10 - .109	5.9		153R150P2000 ●	
		5 - .065	7.5		153R190P2000	
		5 - .065	8.9		157R225P2000	
		5 - .065	10.2	80mm	157R260P2000	
		5 - .065	10.2	80mm	157R260P2000-80	
		5 - .065	11.8	50mm	157R300P2000	
		5 - .065	11.8	80mm	157R300P2000-80	
		5 - .065	11.8	110mm	157R300P2000-110	
2½"	2.875	40 - .203	10.2	80mm	157R260P2500-80	155P2500
		40 - .203	11.8		157R300P2500-80	
		40 - .203	11.8	110mm	157R300P2500-110	
		10 - .120	13.8	80mm	157R350P2500-80	
		10 - .120	13.8	110mm	157R350P2500-110	
3"	3.500	40 - .216	11.8	80mm	157R300P3000-80	155P3000
		40 - .216	11.8	110mm	157R300P3000-110	
		40 - .216	13.8	80mm	157R350P3000-80	
		10 - .120	17.7	110mm	157R450P3000-110	
4"	4.500	40 - .237	13.8	110mm	157R350P400-110	152BP4000
		10 - .120	22.0	110mm	157R560P400-110**	
6"	6.625	40 - .280	23.2	130mm	157R590P6000-130	152BP6000
		10 - .134	31.5	130mm	157R800P6000-130**	



3D Tooling



5D Tooling



Included in standard Pipe Tooling Kits (pg. 16)

80mm drive diameter available for TB80 / TB100 / TB130

110mm drive diameter available for TB130 / TB180

130mm drive diameter available for TB180 only

Bending of non-ferrous material may require tooling modification.

*Select models require counterbending die support 050E when bending radii 225mm and larger.
Refer to machine manual for CLR capacities and drive.

All standard Ercolina® counterbending dies are provided in bronze.

**Center Former Part# 157R560P400-110 and 157R800P6000-130 require lead time



Tooling for Round Tube

Tube Size	Outside Diameter	Wall Thickness	Minimum CLR Inch	Drive Diameter	Center Former Part#	Counterbend Die Part#
1/4"	.250	.035	1.4	40mm	153R036T0250	154T0250
3/8"	.375	.035	1.4		153R036T0375	154T0375
1/2"	.500	.035	1.4		153R036T0500	154T0500
5/8"	.625	.083	1.4		153R036T0625	154T0625
		.035	1.8		153R046T0625	
3/4"	.750	.083	1.8		153R046T0750	154T0750
		.065	2.2		153R056T0750	
		.035	2.6		153R067T0750 ● ●	
7/8"	.875	.083	1.8		153R046T0875	154T0875
		.065	2.2		153R056T0875 ●	
		.035	2.6		153R067T0875 ●	
1"	1.000	.083	2.2		153R056T1000	154T1000
		.065	2.6		153R067T1000 ●	
		.035	3.2		153R082T1000 ●	
1 1/8"	1.125	.095	2.2		156R056T1125	154T1125
		.083	2.6		153R067T1125	
		.035	3.2	153R082T1125		
1 1/4"	1.250	.095	2.6	153R067T1250	154T1250	
		.083	3.2	153R082T1250 ●		
		.035	4.4	153R112T1250 ●		
1 3/8"	1.375	.083	3.2	153R082T1375	154T1375	
		.035	4.4	153R112T1375		
1 1/2"	1.500	.109	3.5	153R090T1500	154T1500	
		.083	3.9	153R100T1500 ●		
		.083	4.4	156R112T1500		
1 1/2"	1.500	.065	5.1	153R130T1500	154T1500	
		.049	5.9	153R150T1500 ●		
		.035	6.7	156R170T1500		
		.035	7.5	153R190T1500		
1 5/8"	1.625	.109	3.5	153R090T1625	154T1625	
		.083	3.9	153R100T1625		
		.065	5.1	153R130T1625		
		.049	5.9	153R150T1625		
		.035	6.7	153R170T1625		
		.035	7.5	153R190T1625		
1 3/4"	1.750	.109	3.9	153R100T1750	154T1750	
		.095	5.1	153R130T1750		
		.095	5.9	153R150T1750		
		.065	6.7	153R170T1750 ●		
		.035	7.5	153R190T1750		

Tooling for Round Tube

- Continued from previous page -

Tube Size	Outside Diameter	Wall Thickness	Minimum CLR Inch	Drive Diameter	Center Former Part#	Counterbend Die Part#
1 7/8"	1.875	.109	3.9	50mm	153R100T1875	154T1875
		.095	5.1		153R130T1875	
		.083	5.9		156R150T1875	
		.065	6.7		153R170T1875	
		.035	7.5		153R190T1875	
2"	2.000	.109	4.7		153R120T2000	154T2000
		.109	5.1		156R130T2000	
		.095	5.9		153R150T2000 ●	
		.083	6.7		156R170T2000	
		.065	7.5		153R190T2000 ●	
2 1/8"	2.125	.134	4.7		153R120T2125	154T2125
		.109	5.1		153R130T2125	
		.083	5.9		153R150T2125	
		.083	6.7		156R170T2125	
		.065	7.5		153R190T2125	
2 1/4"	2.250	.109	5.1	153R130T2250	154T2250	
		.095	5.9	153R150T2250		
		.083	6.7	156R170T2250		
		.083	7.5	153R190T2250		
2 3/8"	2.375	.109	5.1	153R130T2375	154T2375	
		.095	5.9	153R150T2375		
		.083	6.7	156R170T2375		
		.083	7.5	153R190T2375		
2 1/2"	2.500	.187	8.9	157R225T2500*	154T2500	
		.156	9.8	157R250T2500*		
		.120	10.2	157R260T2500*		
		.065	11.8	157R300T2500*		
3"	3.000	.187	9.8	157R250T3000*	154T3000	
		.156	10.2	157R260T3000*		
		.120	11.8	157R300T3000*		
3"	3.000	.216	10.2	157R260T3000-80	154T3000	
		.156	11.8	157R300T3000-80		
3 1/4"	3.250	.216	11.8	80mm	157R300T3250-80	152BT3250
3 1/2"	3.500	.216	11.8	157R300P3000-80	155P3000	
		.216	13.8	157R350P3000-80		
4"	4.000	.216	13.8	110mm	157R350T4000-11	155BT4000

● Included in standard small radius
Tube Tooling Kits (pg. 17)

● Included in standard large radius
Tube Tooling Kits (pg. 17)

80mm drive diameter available for TB80 / TB100 / TB130

110mm drive diameter available for TB130 / TB180 – 130mm drive diameter available for TB180 only

Bending of non-ferrous material may require tooling modification.

*Select models require counterbending die support 050E when bending radii 225mm and larger.

Refer to machine manual for CLR capacities and drive.

All standard Ercolina® counterbending dies are provided in bronze.



Tooling for Square Tube

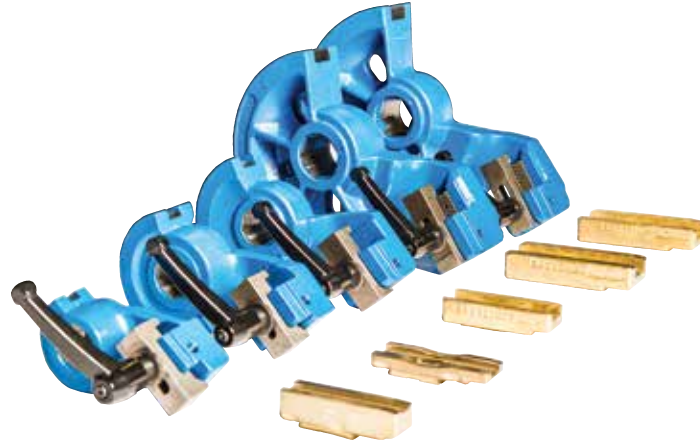

Square Tube Tooling Kits

Description	Material Size	CLR -Inches-	Min. Wall	Center Former Part#	Counterbend Die Part#	Available with Ercolina Machines
TUBEKITSQ1	1/2"	1.8	.049	1582AR0460500	1591A0500	SB48, TB60 TB80, TB100 TB130
	3/4"	2.6	.065	1583AR0670750	1591A0750	
	1"	3.0	.120	1583AR0761000	1591A1000	
	1 1/4"	5.1	.120	1587AR1301250	1591A1250	
	1 1/2"	5.9	.120	1588AR1501500	1591A1500	
TUBEKITSQ2	1/2"	1.8	.049	1582AR0460500	1591A0500	TB60, TB80 TB100, TB130
	3/4"	2.6	.065	1583AR0670750	1591A0750	
	1"	3.0	.120	1583AR0761000	1591A1000	
	1 1/4"	5.1	.120	1587AR1301250	1591A1250	
	1 1/2"	5.9	.120	1588AR1501500	1591A1500	
	2"	5.9	.120	1588AR1502000	1591A2000	

Material Extraction Device for Square Tube

Extractor plate assists in square material extraction for profiles, solid and hollow.



Part# FP500P1-A
For use on 030 Mega Bender, TB60, SB48 and 48 Plus models.



Part# FP500P1-TB80
For use on TB80 model.

Part# FP500P1-TB100
For use on TB100 model.

Part# FP500P1-TB130
For use on TB130 model.

Tooling for Square Tube

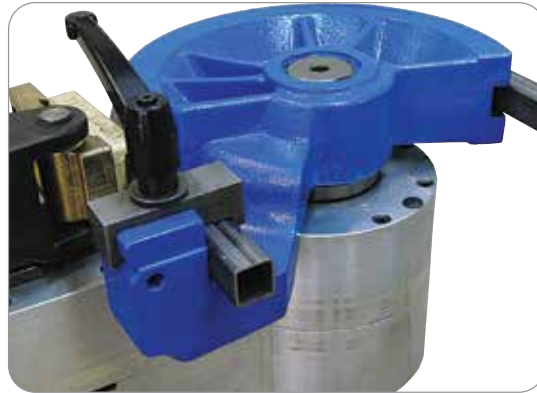

Tube Size	Outside Diameter	Wall Thickness	Minimum CLR Inch	Drive Diameter	Center Former Part#	Counterbend Die Part#
1/2"	.500	.065	1.4	40mm	1582AR0360500	1591A0500
		.049	1.8		1582AR0460500	
3/4"	.750	.120	1.8		1582AR0460750	1591A0750
		.065	2.6		1583AR0670750	
1"	1.000	.120	3.0	1583AR0761000	1591A1000	
1"	1.000	.083	3.9	50mm	1585AR1001000	1591A1000
		.065	5.1		1587AR1301000	
		.049	5.9		1588AR1501000	
1 1/4"	1.250	.120	5.1		1587AR1301250	1591A1250
		.095	6.6		1589AR1701250	
1 1/2"	1.500	.120	5.9		1588AR1501500	1591A1500
		.095	7.4	15810AR1901500		
2"	2.000	.120	5.9	1588AR1502000	1591A2000	
		.095	7.4	15810AR1902000		
2 1/2"	2.500	.125	11.8	15813AR30025-80	1591A2500	
3"	3.000	.187	13.8	15814AR35030-80	1591A3000	

2-1/2" Square – 80mm drive diameter (15813AR30025-80) available for TB80 / TB100 / TB130

3" Square – 80mm drive diameter (15814AR35030-80) available for TB100 / TB130

Consult factory for tooling sizes not shown.





Round Tube Information

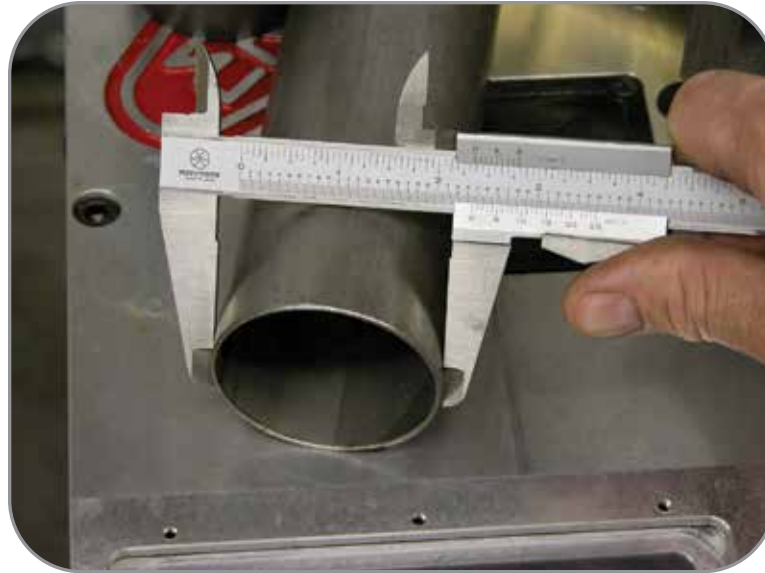

Tube dimensions are based on O.D. of material (2" tube measures 2.00" O.D.).

Steel & Polymer Tube Counterbending Dies

STEEL

Tube Size	Outside Diameter	Counterbend Die Part#
3/4"	.750	154AT0750
7/8"	.875	154AT0875
1"	1.000	154AT1000
1 1/4"	1.250	154AT1250
1 3/8"	1.375	154AT1375
1 1/2"	1.500	154AT1500
1 3/4"	1.750	154AT1750
1 7/8"	1.875	154AT1875
2"	2.000	154AT2000
2 1/4"	2.250	154AT2250
2 1/2"	2.500	154AT2500

Steel used for heavy wall or abrasive application.

Consult factory for tooling sizes not shown.

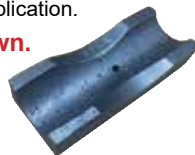

STEEL SUPPORT WITH REPLACEABLE POLYMER INSERT

Tube Size	Outside Diameter	Counterbend Die Part#
1 3/8"	1.375	154ST1375
1 1/2"	1.500	154ST1500
1 3/4"	1.750	154ST1750
1 7/8"	1.875	154ST1875
2"	2.000	154ST2000

Polymer recommended for materials with a polished finish such as stainless and aluminum.



REPLACEABLE POLYMER INSERT

1 3/8"	1.375	154ST1375INS
1 1/2"	1.500	154ST1500INS
1 3/4"	1.750	154ST1750INS
1 7/8"	1.875	154ST1875INS
2"	2.000	154ST2000INS

All tooling is manufactured for mild steel general tube and pipe dimensions. Tooling groove is slightly undersized - designed to better form tube shape throughout bend.

Tooling can be modified to customer's required dimensions and or polished at additional cost to improve finish. Contact Ercolina customer service for additional information at (563) 391-7700.

Rotary Draw Accessories

Spray Bending Lubricant



Part# **810**
One (1) 12 oz. can

Part# **811**
Case of Nine (9) 12 oz. cans



Tie Bar Accessory

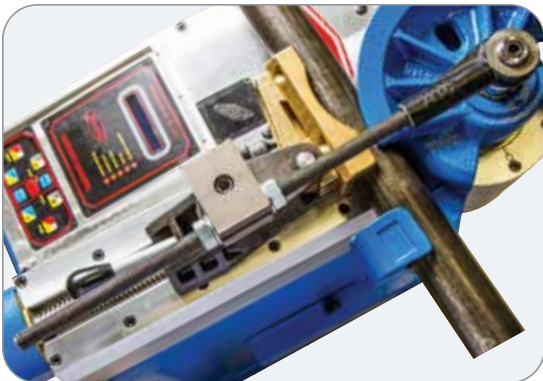

Part# **030TIEBAR**

For use on 030 Mega Bender, TB60, SB48 and 48 Plus.

Tie bar accessory should always be used when bending heavy wall profiles and solid materials.

Center Former Reinforcement Kit



Part# **REINFKIT**

For tooling R67 and larger.
Available and interchangeable for all round tube or pipe center formers up to 7.5" radius (R190).

Increases the rigidity of standard rotary draw tooling. Recommended for use when bending heavy wall material or solid bar stock.



Rotary Draw Accessories

Roller Counterbending Dies



Part# **050I** from $\frac{3}{8}$ " to $2\frac{3}{8}$ "

Part# **050J** from $2\frac{1}{2}$ " to 3"

***MUST SPECIFY MATERIAL DIAMETER
WHEN ORDERING***

Available for round and square profiles, roller dies are recommended when bending high tensile materials, solids and heavy wall profiles.

Note: Roller dies must be positioned a minimum of $2\frac{1}{2}$ " from face of center former; failure to do so will cause machine damage.

Not suitable for bends beyond 130° .

Counterbending Die Adapter Plate



Part# **CBDAP**

High quality, machined, aluminum bracket used to interchange between cam lock and drop in style counterbending dies.







Counterbending Die Support









Part# **050E**
(replaces standard vise)



GENERAL PRODUCTION MODELS

Profile Description	SB48	TB60
 Mild Steel Pipe	1½" Sch. 40	2" Sch. 40
 Stainless Steel Pipe	1¼" Sch. 10	1½" Sch. 40
 Mild Steel Square Profile	1½" x 1½" x ⅛"	2" x 2" x ⅛"
 Mild Steel Rectangular Profile (Easy Way)	¾" x 1½" x .120"	1" x 2" x .120"
 Mild Steel Rectangular Profile (Hard Way)	1½" x ¾" x .120"	2" x 1" x .120"
 Mild Steel Solid Rod	1⅝"	1¼"

HEAVY-DUTY INDUSTRIAL MODELS

Profile Description	TB80	TB100	TB130	TB180
 Mild Steel Pipe	2½" Sch. 40 Grade B	3" Sch. 40	4" Sch. 40	6" Sch. 40
 Stainless Steel Pipe	2½" Sch. 10	2½" Sch. 40	3" Sch. 80	4" Sch. 80
 Mild Steel Square Profile	2½" x 2½" x ⅛"	3½" x 3½" x ⅛"	4" x 4" x ⅛"	4" x 4" x ¼"
 Mild Steel Rectangular Profile (Easy Way)	2" x 3" x .125"	2" x 4" x .187"	2" x 4" x .250"	2" x 4" x .250"
 Mild Steel Rectangular Profile (Hard Way)	3" x 2" x .125"	4" x 2" x .120"	4" x 2" x .187"	4" x 2" x .250"
 Mild Steel Solid Rod	1½"	2"	2½"	3"

All capacities based on A53 grade A 48,000 psi tensile materials; heavy wall and high tensile materials reduce machine capacity. Consult supplier for material specifications.



A40/P Two Axis Positioner

Ideal for repetitive parts
and left & right mirror images

Part# A40/P
Accommodates parts
to 10' length



Capacities & Specifications

Height	43"
Length	110"
Width	32"
Material Capacity Through Spindle (Max.)	1/2" – 2-3/8"
Chuck Rotation	1" O.D. 360°
Weight	180 lbs.

Consistency Repeatability Increased Profitability

FEATURES

- Manually controls accurate linear (Y) advancement and rotational (B) plane of bend
- Reduces operating handling and labor costs
- Helps eliminates unnecessary material scrap
- Previous layout and design experience not required
- Adapts to Ercolina 030 Mega Bender, TB60, SB48 and 48 Plus machines
- Pneumatic work holding chuck secures material and rotates 0-360°
- Chuck activation valve conveniently positioned near operator and machine controls
- Includes: four (4) sets of chuck jaws for material 1/2" to 2 3/8", six (6) adjustable linear and rotary stops
- Optional digital readout of linear and rotational bends
- Custom length tables available on request

Note: Positioner not intended for solid profiles

Quickly layout and produce drawings for bending applications!

Ideal for use with A40/P two axis positioner.



Part# **BENSW-SUPER**

Reduce layout cost

FEATURES

- Eliminate unnecessary material scrap
- Previous layout and design experience not required
- Mouse pick points allow dimension placement
- Dimension with decimals or fractions
- Save part program files for later use
- Information material data base included
- CLR or inside radius (adjustable for each bend)
- Create printable dimensioned model, shaded model, flat layout & title block
- Flat layout of cut length & bending locations
- Can be dimensioned from start of bend, end of bend & center of bend, or either direction
- Provides springback bend angle
- Print includes bending data such as bend angles, CLR or inside radius, rotation angle & bend order
- Preferences: color, text size & arrow size are saved in user definable data bases
- Verifies sufficient material is available for bending process
- Extra checking tools provided to verify part validity
- Allows multiple dies to be used on the same part
- Graphical layout interface provided
- Advanced LRA "Length, Rotation & Angle" design interface
- Powerful reverse engineering feature
- Inch to metric conversion
- CD-ROM Windows XP or higher required
- All standard Ercolina tooling included in tooling library
- LRA: transfers any part into XYZ data when entering LRA information into Custom Part interface; XYZ data available
- Railing Templates: includes hand railing template
- Chord measuring tool for large radius bending
- File Import/Export
- Estimating: Helps define project cost

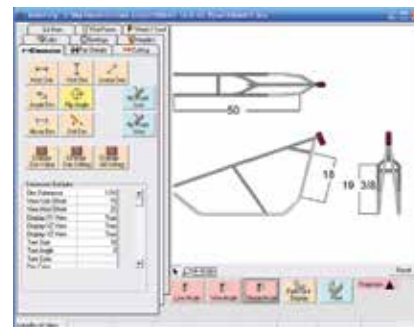

Assembly Drawing

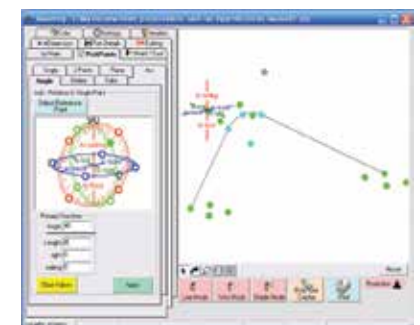

XYZ



Handrail Simulation Samples

Wall Rail

Material: 1¼" Schedule 40
Tooling: 1.660 Pipe R90
CLR: 3.5
Cal. CLR: 3.550
Cut Off Start End: 5.25
Cut Off Far End: 5.25

Shop Instructions:

Cut Length: 132 5/16

A	B	Location	Rotation	Angle	CLR
1	1	4 1/4	0	90	3.5
2	2	17 3/16 Flip	(-90)	32	3.5
4	3	128 1/16	(-90)	90	3.5
3	4	115 1/16	(-90)	32	3.5



Design Instructions: Custom Part

Cut Length:

A	Length	Rotation	Angle	Type
1	2.5	0	90	Apex
2	12	-90	32	Apex
3	96	180	32	Apex
4	12	-90	90	Apex
E	2.5			

Bleacher

Material: 1¼" Schedule 40
Tooling: 1.660 Pipe R90
CLR: 3.5
Cal. CLR: 3.550

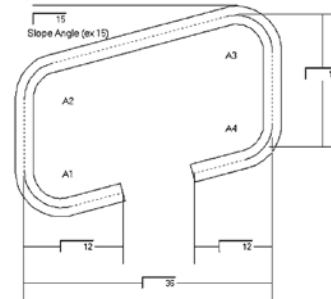

Handicap Rail

Material: 1¼" Schedule 40
Tooling: 1.660 Pipe R90
CLR: 3.5
Cal. CLR: 3.550

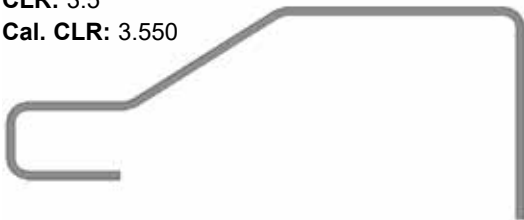

A	B	Location	Rotation	Angle	CLR
5	1	18 1/2	0	90	3.5
4	2	31	0	90	3.5
3	3	55 15/16	180	32	3.5
2	4	91 7/8	180	32	3.5
1	5	137 5/16	0	90	3.5

Design Instructions: Custom Part

Cut Length:

A	Length	Rotation	Angle	Type
1	42	0	90	Apex
2	48	0	32	Apex
3	36	0	-32	Apex
4	24	0	90	Apex
5	14	0	90	Apex
E	22			

Location Rotation Bend

Bend Number: 1 Location: 18 1/2 Rotation: 0 Bend Angle: 90			
Bend Number: 2 Location: 31 Rotation: 0 Bend Angle: 90			
Bend Number: 3 Location: 55 15/16 Rotation: 180 Bend Angle: 32			
Bend Number: 4 Location: 91 7/8 Rotation: 180 Bend Angle: 32			
Bend Number: 5 Location: 137 5/16 Rotation: 0 Bend Angle: 90			

NC & CNC MANDREL BENDERS

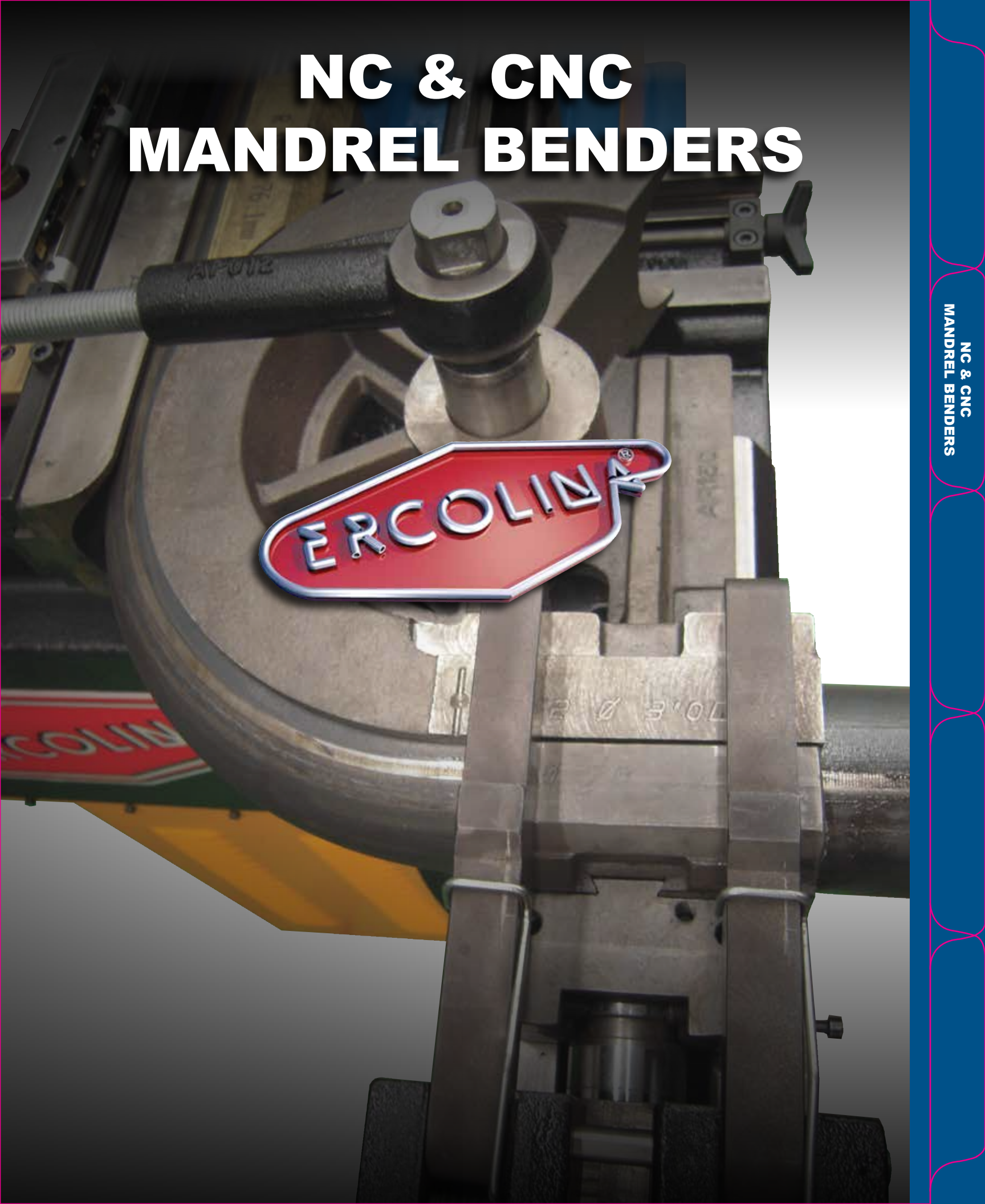

NC & CNC Mandrel Benders Table of Contents

- 030 Mandrel Bender34-35
- TB80 Mandrel Bender36-37
- EB65 & EB76 Mandrel Bender38-41
- Model selection chart42
- Mandrel tooling order form43
- Mandrel information.....44-45
- Mandrel tooling information46-47
- QR codes to view mounting mandrel tooling instruction videos47
- Standard pipe mandrel tooling sets.....48
- Standard tube mandrel tooling sets.....49-51
- Square tube mandrel tooling sets.....51
- CuNi class 200 mandrel tooling sets and size chart.....52
- Factory training included with machine purchase53
- Material overview common tube and pipe.....54
- Mandrel bending troubleshooting55-56



NC & CNC MANDREL BENDERS

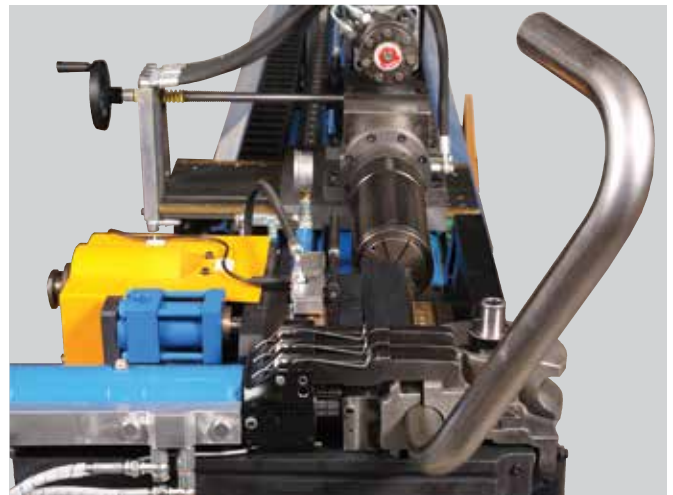



030 Mandrel Bender

NC Semi-Automatic Rotary Draw Mandrel Bender

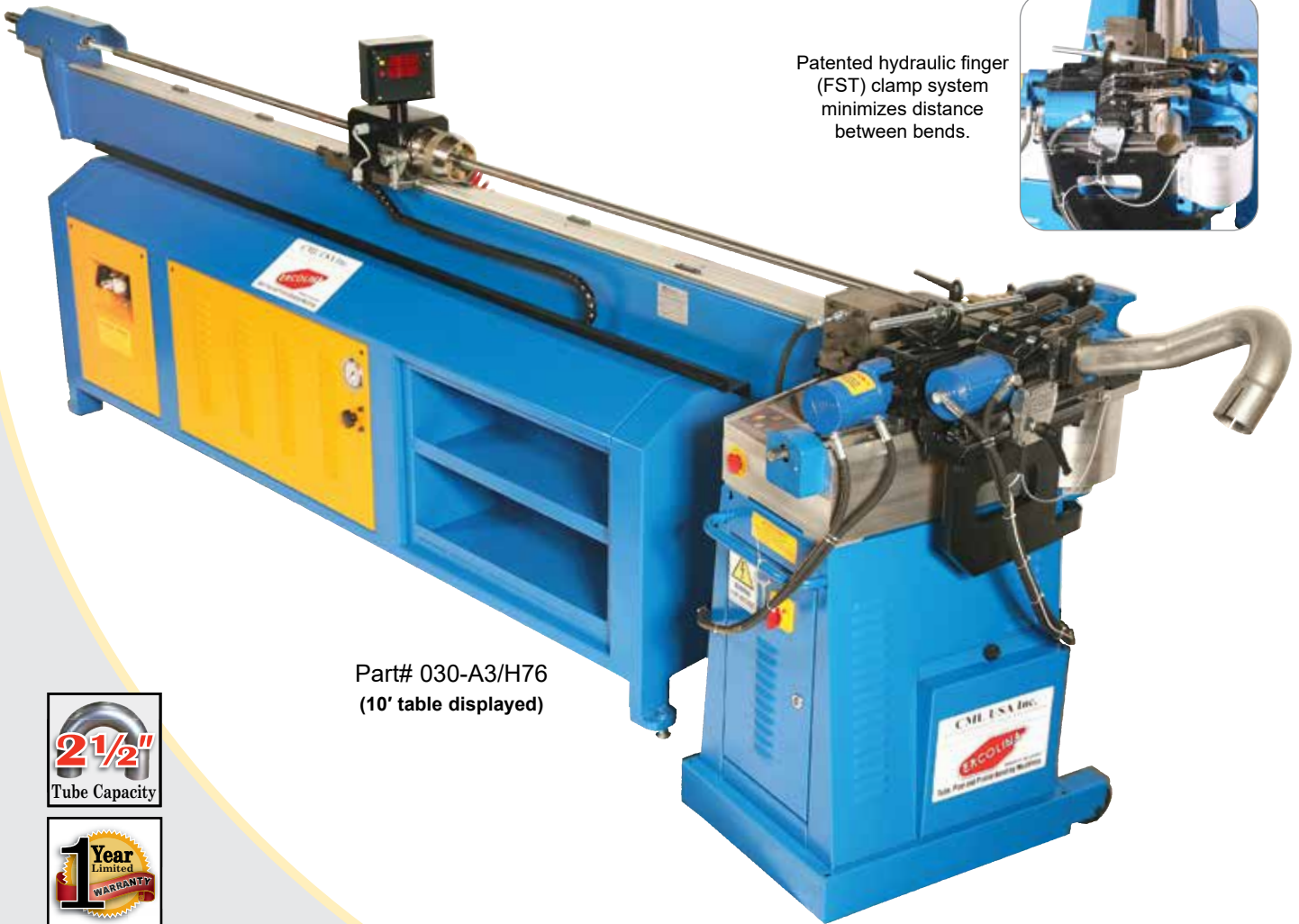

Patented hydraulic finger (FST) clamp system minimizes distance between bends.



Part# 030-A3/H76
(10' table displayed)



Prototype or Small Production Applications

FEATURES

- Variable bending speed
- Ideal for bending handrail, thin wall mild steel, stainless steel, bend grade aluminum and other materials
- Programmable bend sequencing and mandrel retraction
- Independent clamp and pressure die adjustment
- Reinforced tool mounting shaft with heavy duty swing arm for maximum rigidity
- Micrometer wiper die adjustment
- Secondary hydraulic pressure die stabilization system
- Quick-change tooling reduces setup time
- Tables available in 5', 10' or 20' lengths; standard with pneumatic material clamping and DRO system for linear and rotational positioning
- Bending software available for part layout guideline
- Base machine converts to accept Ercolina non-mandrel tooling
- Reference display of Y & B axis to assist set-up
- Y - Feeding manual with adjustable stops
- B - Feeding manual with adjustable stops
- C - NC programmable bend angle

030 Mandrel Capacities & Specifications

Max. Tube Capacity – Mild Steel	2½" (.083 wall)
Stainless	2½" (.065 wall)
Square Tube	2" (.065 wall)
Max. Pipe Capacity	1½" Sch. 40
Max. Bending Radius	7⅞"
Min. Bending Radius	1.5 x Ø
Max. Shaft Rotation	210°
Max. Bending Angle	180°
Max. Tailstock Capacity	2⅜"
Max. Material Length – 5' table	59"
10' table	118"
20' table	240"
Mandrel Table (available in 5'-10'-20' lengths)	165"
Number of Programs	(30) Standard
Precision of Bend Angle	+/- 1°
Power	Three Phase 220V or 480V
Dimensions (Height x Width x Length)	44" x 32" x 83"-260"
Weight	1,600 lbs.

Contact CML USA for complete technical specifications.

All capacities based on mild grade materials; heavy wall and high tensile materials reduce machine capacity.



◀ Ercolina Bending Application

**Product
Demonstrations
Available on Website**

**NEED ADDITIONAL HELP?
CONTACT ERCOLINA:**

563.391.7700

info@ercolina-usa.com



TB80 Mandrel Bender

NC Semi-Automatic Rotary Draw Mandrel Bender



Part# TB80-A/P80NC



Ideal for Prototype or Daily Production

FEATURES

- Control swings out to offer easy access to manual and auto operating modes, system diagnostics and multiple languages
- Unlimited storage of bend programs, material library and job information (optional)
- Touch screen displays absolute (ABS) or incremental (INC) positioning with inch or metric readout
- Programmable C axis with manual Y and B positioning
- Variable bending speed to 3 RPM with overload protection
- Programmable bend angle 0 to 180°
- Individual material springback and speed settings for every bend angle
- Anticipated mandrel retraction, clamping, pressure die and boost die movements
- Pressure die with auto recapture minimizes distance between bends
- Heavy duty tailstock carriage with segmented collet hydraulic clamping of workpiece
- Tailstock Y and B position display resets to zero after each bend for easy setup while maintaining absolute position

TB80 Mandrel Capacities & Specifications

Max. Tube Capacity – Mild Steel	3" (.125 wall)
Stainless	3" (.083 wall)
Square Tube	2½" (.083 wall)
Max. Pipe Capacity	2½" Sch. 10
Max. Bending Radius	8.8"
Min. Bending Radius	1.5 x Ø
Max. Shaft Rotation	210°
Max. Bending Angle	180°
Max. Tailstock Through Capacity	3"
Max. Material Length – standard table	13'
Optional Table Extension	21'
Program Storage	USB Optional
Precision of Bend Angle	+/- 1°
Power	Three Phase 220V or 480V
Dimensions (Height x Width x Length)	61" x 36" x 179" or 251"
Weight (13' or 21' table)	2,000 lbs. or 2,600 lbs.

Contact CML USA for complete technical specifications.

All capacities based on mild grade materials; heavy wall and high tensile materials reduce machine capacity.



Patented finger style (FST) clamping system minimizes clamping area.

- Bending head adjusts horizontally to maintain centerline radius of former allowing table to remain stationary
- Patented finger style (FST) clamping system minimizes distance between bends
- Direct drive electro-mechanical bending axis
- Precision encoders on all axes for greater repeatability
- Heavy one-piece steel structure improves rigidity and minimizes vibration
- Externally mounted gauges for adjustment of system and clamping pressure
- Accepts standard 030 mandrel tooling
- Electrical components UL, CSA and CE approved
- Programmable internal lubrication available
- Y - Feeding manual with adjustable stops
- B - Feeding manual with adjustable stops
- C - NC programmable bend angle
- Accepts optional mandrel lubrication pump



EB65 & EB76 Mandrel Bender

CNC Automatic 3 Axis Mandrel Bender

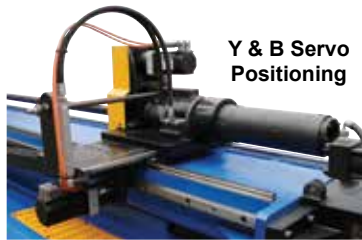

Y & B Servo
Positioning

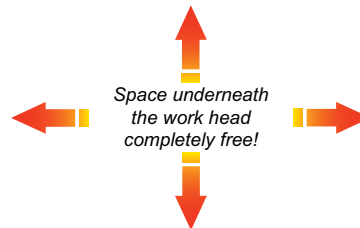

Space underneath
the work head
completely free!

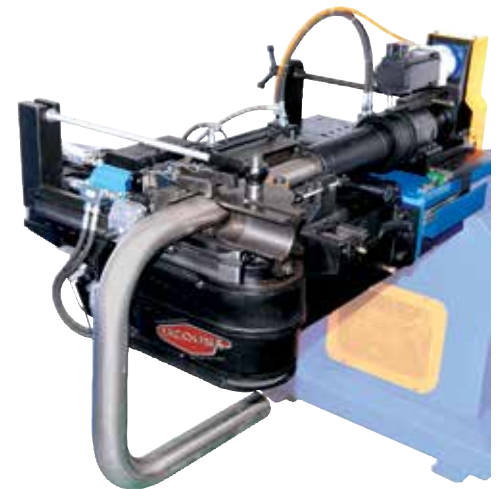

Part# EB76CNC6V5



Fully Automatic – Cost Effective

FEATURES

- Extended bending head capable of bending complex shapes and profiles
- Automatic or manual bend sequencing
- Independent pressure and clamp die adjustment
- Programmable carriage movement for tight radii
- Interactive touch screen with auto and manual operating modes, system diagnostics and multiple language capability
- Standard right hand bending direction
- Programmable material springback settings for each bend angle
- Programmable auto mandrel positioning allows operator to optimize extraction for improved bend quality
- Programmable tail stock interference zone monitors position and eliminates workhead collision
- USB for unlimited program memory storage and communication
- Tangent or centerline programming
- Hand-held remote bending control, certified class 3 safety and all electrical components UL, CSA and CE approved

EB65 & EB76 Mandrel Capacities & Specifications

12/20/50

Model	EB65	EB76
Max. Tube Capacity – Mild Steel	2½" (.083 wall)	3" (.083 wall)
Stainless	2½" (.065 wall)	3" (.065 wall)
Square Tube		2" (.065 wall)
Max. Pipe Capacity	1½" Sch. 40	2" Sch. 40
Max. Bending Radius	9.8"	9.8"
Min. Bending Radius	1.5 x Ø	1.5 x Ø
Max. Shaft Rotation	210°	210°
Max. Bending Angle	185°	185°
Max. Tailstock Capacity	2½"	3"
Interactive Touch Screen Control	10" color screen	10" color screen
Max. Material Length – Standard table	13'	13'
Optional Table Extension	21'	21'
Minimum Underhead Swing Clearance	14.5"	15.5"
Length of Bending Head	59"	59"
Maximum Carriage Travel	125"	125"
Number of Programs	Unlimited	Unlimited
Precision of Bend Angle	+/- .5°	+/- .5°
Power	Three Phase 480V	Three Phase 480V
Dimensions (Height x Width x Length)	52" x 44" x 205"	52" x 44" x 205"
Weight	7,200 lbs.	7,400 lbs.

Contact CML USA for complete technical specifications.

All capacities based on mild grade materials; heavy wall and high tensile materials reduce machine capacity.

- Graphic bend simulation software included
- Programmable internal mandrel lubrication (3 settings)
- High capacity with auxiliary hydraulic oil cooling
- Quick-change tooling system
- Standard 13' table, extension available
- Tail stock with through spindle accepts longer material
- Accepts YBC and XYZ input values
- Y - Feeding Electric Servo
- B - Rotation Electric Servo
- C - Bending Hydraulic CNC
- Accepts optional mandrel lubrication pump



Ercolina's handrail professional series package includes:

- Erco Bender three axis CNC automatic bending machine
- 1-1/4" pipe schedule 40 set complete
- 1-1/2" pipe schedule 40 set complete
- 1-1/2" tube for .120 wall set complete
- Auto mandrel lubrication pump
- Bendtech software for external computer
- Machine training at factory



- Produce handrail to design in minutes
- Dramatically reduce operator handling and shop labor cost
- Improve quality to your customers providing mandrel quality bends in steel, stainless and aluminum
- Eliminate additional cost of weld elbows, material waste, weld, grind and finish operations
- Control your production time and process
- Quickly store and recall previous handrail programs
- Ercolina's tool set data files maintain machine start position enabling the operator to quickly change to the next job
- Optional software available - directly imports properly formatted IGES/Tekla and Dxf engineering files from compatible CAD programs
- Create your own data with optional Bend-Tech software
- Additional professional on-site machine training (optional)

Erco Bender Interactive Touch Screen Control Panel

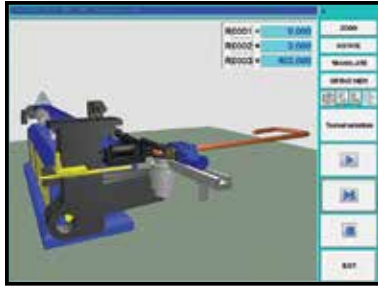

GRAPHIC SIMULATION



PART LAYOUT



TOUCH SCREEN PROGRAMMING



MAIN SCREEN



BEND ANGLE & SPRINGBACK



STORE ALL TOOL SET INFORMATION



STORE MATERIAL INFORMATION

Interactive CNC Control Available on these Models:

▶ Erco Bender 65

▶ Erco Bender 76



Model Selection Chart

Model	030 Mandrel Bender	TB80 Mandrel Bender	Erco Bender 65 / 76
OPERATOR CONTROL			
LCD with PLC touchpad	✓		
Color touch screen		✓	✓
Independent control of Clamp, Mandrel Functions	✓		
Manual override control of Clamp, Pressure Die, Boost, Mandrel, Clamp release function		✓	✓
Inch or Metric display	✓		
Inch and Metric programming and display		✓	✓
Manual or Semi Auto mode	✓	✓	
Manual, Semi Auto and Auto modes			✓
PROGRAMMING			
(30) programs - up to (9) bend angle and springback settings per program	✓		
Unlimited program storage with USB		✓	✓
MACHINE DESIGN			
C axis electro mechanical operation with gear reduction. Main frame aluminum case.	✓		
C axis electro mechanical operation with planetary reduction. Main frame GS500 cast steel case.		✓	
C axis hydraulic operation with rack and pinion. Main frame GS500 cast steel case.			✓
Analog encoders for C axis, Counter Die Axis display position on control. LED on table to monitor length and rotation from original bend plane (YB).	✓		
Digital encoders for three axis with digital display of absolute or incremental position on touch screen.		✓	✓
Tailstock pneumatic clamping with four interchangeable jaw sets. 2 ³ / ₈ " capacity.	✓		
Tailstock hydraulic clamping with segment collet. 2" through spindle capacity, 3" material capacity with collet.		✓	
Tailstock hydraulic clamping with segment collet. 2 ³ / ₈ " through spindle capacity, 3" material capacity with collet.			✓
Programmable mandrel retraction	✓	✓	✓

Factory on-site training available.

Contact CML USA for complete technical specifications.

All capacities based on mild grade materials; heavy wall and high tensile materials reduce machine capacity.

Mandrel Tooling Order Form

Fax Completed Form To: (563) 391-7710

Company Name: _____ Contact: _____ Date: _____
 Address: _____
 City: _____ State: _____ Zip: _____
 Telephone: _____ Fax: _____ Email: _____
 Distributor Name: _____ Contact: _____

Material Specifications:

Tube/Pipe Dimensions: _____ OD _____ ID
 Wall Thickness: _____
 Material Type/Grade: _____
 Weld Seam: _____ Yes _____ No
 No. Parts Per Day: _____ No. Bends Per Part: _____
 Prints Supplied: _____ Yes _____ No
 Are Mill Certs Available _____ Yes _____ No
 Centerline Radius (CLR): _____
 Min. Dist. Bet. Bends (G): _____
 Outside Diameter (OD): _____
 Maximum Degree of Bend: _____

Center Former

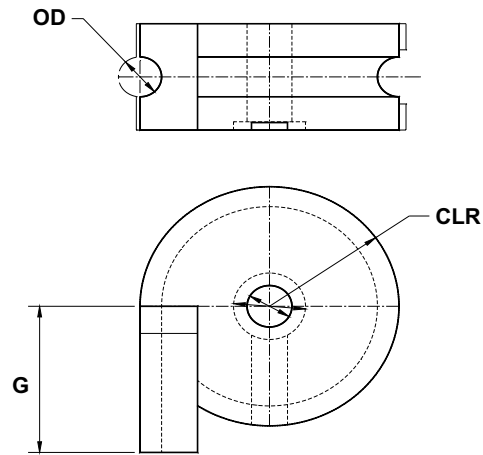

Mandrel Information:

Mounting Thread on Mandrel (MT): _____
 Length of Shank (L): _____
 Number of Spheres Required: _____
 Diameter of Mandrel (D): _____
 Mandrel Material: _____ AMPCO Bronze _____ Steel/Chrome Plated

Mandrel

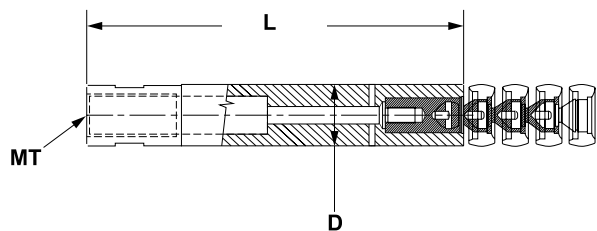

Pressure Die: _____ Steel _____ Polymer
 Wiper Die Required: _____ Yes _____ No
 Clamp Die: _____ Smooth _____ Serrated

Notes: _____

I have reviewed the above information for accuracy and confirm it is correct. Any alterations made from original information will result in additional cost and may extend delivery time.

_____ Customer Signature

_____ Date



When is a mandrel necessary?

When a tube is bent the outside wall collapses and thins out, and the inside compresses. When bending thin wall tube to tight radius a mandrel and wiper die are necessary. Use of a mandrel minimizes the amount of ovality occurring during bending.

Machine and tooling basics

Machine capacity and features will vary based on application and production requirements. Ercolina produces both NC and CNC machines designed to accommodate job shop to moderate production applications. The correct selection of machine model, tooling and material will ensure success in bending. There are many factors to consider with selecting tooling. Generally parts with several bends or higher quantity may require a CNC machine. Parts with one centerline radius are the easiest to accommodate. Always encourage designer of the parts to use a single bend radius when possible. Most applications can modify the radius with little effect on the overall part design and make the bending process more productive. Using the largest possible radius will closely maintain shape of the material after the bend. Ideally mandrel bending to radius 2-3 times material diameter will yield the best results. Ercolina standard tooling sets are available in 2D and radius is base centerline radius (CLR).

Information required for mandrel tooling applications

- Size and wall thickness of material
- Material type and grade
- Number of bends on part
- Distance between bends
- Plane of bend relationship to one another
- Production rates
- Part tolerances
- Centerline radius of the bends. **Note:** bends with radius less than 2 times OD require greater attention, high grade bendable materials and heavier machine design.

Understanding material to be bent

Bending application success is dependent on several factors including and most importantly the proper material. Obtain a print of work to be done, review dimensions and tolerances. Review the mill certification for material from the mill and confirm the material is appropriate for bending. Use caliper to measure material and confirm dimensions are correct for tooling. Tube OD and wall thickness variations are far more common than you may realize. For some tube fabricating applications, this variation is of little concern, but in mandrel bending, ID dimension variation is a big issue. The tubing must fit the tooling and mandrel correctly and have the appropriate clearances. **Note:** tubing with no or minimal internal seam is preferred with mandrel bending. Material with heavy weld seam will interfere with mandrel and require tooling modification. Different types of material can be bent i.e., steel, aluminum, and stainless however the tooling composition and CLR may change to ensure material compatibility. Pay attention to material ordered and confirm it's received as ordered.

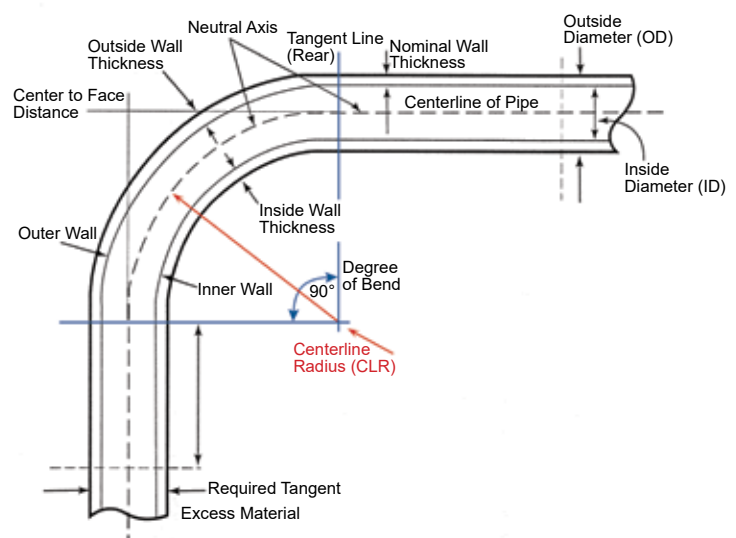

Terminology

Bend Specifications

OD is tube outside diameter, usually measured in inches or millimeters. Sometimes the tube outside diameter is expressed in nominal, such as IPS for pipe. Only rarely is a tube diameter specified as an inside diameter. This is non-standard, leads to confusion, and should be avoided. Whatever units are used, OD should be expressed in decimal, to three places in the case of inches.

WT is wall thickness. Inches and millimeters are common units, and again the precision of a decimal number to three places is warranted if inches are used; at least one place for millimeters. Frequently, the old Birmingham Wire Gage Standard is used to express WT; be sure to use the correct gage (there are several standards) when translating to decimal inches. When the Tube OD is expressed as an IPS nominal size, then the WT is expressed as a schedule number, which corresponds to a precise value in inches.

CLR is centerline radius and is the most common reference for bend radius. Again, inches and millimeters are the common units of measurement. Typically, fractional or two-place decimal inches are sufficiently precise. Sometimes the CLR is expressed as a multiple of the Tube OD, such as "1-D", "2-D", and so on. Note that if the Tube OD is expressed as an IPS nominal size and the CLR is expressed as a "D", it is a multiple of the nominal, not the actual tube diameter. Inside radius, abbreviated "ISR", is a common reference for specifying bend radius if the tubing is non-round. Outside radius is seldom used to define the bend radius.

DOB is degree of bend, often loosely referred to as the sweep of bend or depth of bend. This defines in decimal degrees (occasionally degrees and minutes) the arc of the bend. This is, of course, different from "plane of bend" or "orientation", a specification for multi-bend parts which defines in degrees where the plane of the current bend is located relative to the plane of the first bend.

In defining multi-bend parts, XYZ rectangular coordinates are used, from which bend data are developed. Bend data consist of tangent length, plane of bend, and degree of bend and defines the motion of the tube during the bending process.

Geometry

All bent parts consist of arcs and tangents. The arc is simply the bent portion of the tube, and the tangent the unbent portion.

Inside radius (ISR) and outside radius (OSR) are nominal references defining the extreme inner and outer limits of the tube arc. The centerline radius (CLR) is, of course, the average of these two.

Plane of bend is the plane defined by the inside and outside radii.

Line of tangency is actually a plane, perpendicular to the plane of bend, passing through the origin of the bend and the beginning point of the bend (in other words, it separates the arc of the bend from the tangent section). Before the line of tangency, the tube is straight. Past the line of tangency, it is bent. In draw bending, the line of tangency is fixed in space, through which the tube is drawn around the bend die as it rotates.

Neutral axis vs. centerline radius. It happens that the neutral axis is physically close to the centerline radius, but these terms are not synonymous. The neutral axis is a narrow region, lying inside of the centerline radius, separating the zone of compression from the zone of stretching. At the neutral axis the tube wall neither compresses nor stretches.

Intrados vs. inside radius. The intrados is the zone of compression, bounded by the inside radius and the neutral axis.

Extrados vs. outside radius. The extrados is the zone of stretching, bounded by the outside radius and the neutral axis.

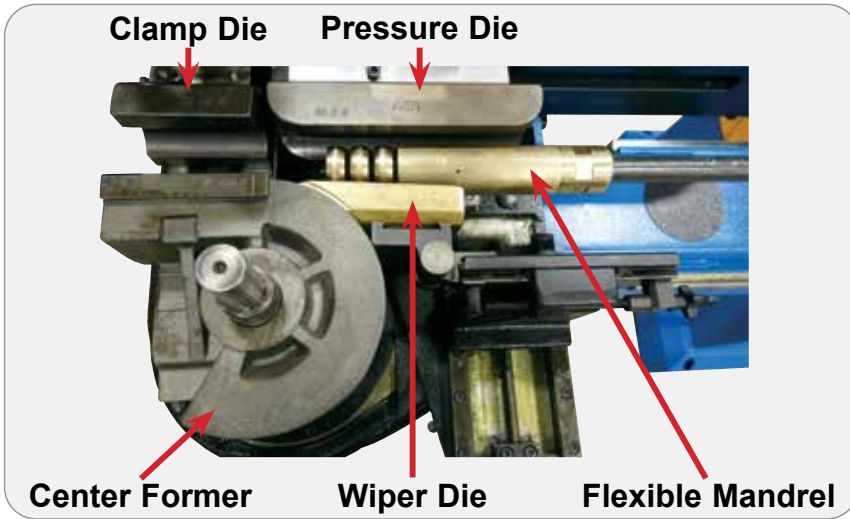

Ercolina mandrel systems incorporate five (5) individual tooling components to effectively support the profile during bending process. These components; **Center former**, **pressure die**, **clamp die**, **wiper die** and **flexible mandrel** are specific to material type, dimension and centerline radius (former & wiper).

TOOLING COMPONENTS OF MANDREL BENDING



Center Former / Bend Die: Primary tool which determines bend radius. Manufactured from tool steel or alloy steel and heat treated depending on requirements. Clamp face is serrated to assist grip strength.

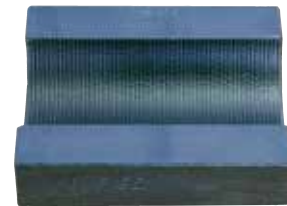

Clamp Die: Matches center former clamp surface. The clamp die's primary function is to hold tube securely to the center former.



Pressure Die: Maintains constant pressure on tube at tangent where the bend occurs, providing reactionary force to make the bend. Length of the pressure die depends on the degree of bend (DOB) of part being bent and the machine design.



Wiper Die: Manufactured to match center former radius. Mounts into the groove of the center former with tip positioned near tangent point of bend. Primary function is to prevent wrinkling on the inside radius of the tube. Wiper dies are typically manufactured from AMPCO® bronze.

Mandrel Tooling Information



Mandrels: Primary function of the mandrel is to prevent inside diameter of the tube from collapsing. Choosing the correct mandrel is very important in determining the quality of bend. Basic styles of mandrels are:

1. **Plug mandrel** used for heavier walled tube or large CLR bending.
2. **Thin wall mandrel (close pitch mandrel)** used mostly for thin wall tubing. Thin wall style mandrels use the same style linkage as standard mandrels except the link size is the next size smaller than it would be on a standard mandrel. For example, where a standard style mandrel would use a #10 size link, a thin wall style mandrel would use a #9 size link. The ball segments are now closer together and provide more support needed for thin walled tube bending. Strength is sacrificed for more support.



2" Stainless Steel
.065 wall – 3" CLR
Cutaway to show mandrel



Spring Collet



Segmented Collet

Collet: The collet is mounted in the tailstock of machine and holds material securely in carriage. Collets are size-specific and must match the tooling mounted on machine.

Bending Lubrication: Comes in several different forms such as oil, grease, and paste. The kind of lubrication used will depend on material to be bent. A generous amount of lubrication may be applied to mandrel and inside of tube, however precautions should be taken to avoid getting lubrication on center former and clamp die. Proper lubrication is important to making good bends.

Bending lubricant is a must in most applications. Proper lubricant will significantly improve the bending process and part quality. After you bend the tube, you're probably going to clean it, weld it, or assemble. Select and use the correct lubricant.

Stainless steels have higher tensile strengths and yield strengths than carbon steels, and require more energy generating more heat. Heat builds up, lubricant moves away from bend. Use lubricants with additives that reduce the amount of heat generated.

MOUNTING MANDREL TOOLING INSTRUCTIONS



STANDARD PIPE MANDREL TOOLING SETS

MATERIAL	WALL	CLR	ITEM CODE	DESCRIPTION	FITS MODEL	
1" Pipe		2.5"	AK20DP1000	Tool Set (Includes 4 items:)	030 Mandrel, TB80 Mandrel, EB65, EB76	
			AR67R067P1000	Center Former		
			A224P1000	Clamp Die		
			A244R067P1000	Wiper Die		
			A204P1000	Pressure Die		
1" Pipe Sch. 5	.065		AXKITSP1000065	Mandrel Flexible STEEL CHROME with Sphere		
1" Pipe Sch. 10	.109		AXKITSP1000109			
1" Pipe Sch. 40	.133		AXKITSP1000133			
1" Pipe Sch. 5	.065		AXKITBP1000065	Mandrel Flexible BRONZE with Sphere		
1" Pipe Sch. 10	.109		AXKITBP1000109			
1" Pipe Sch. 40	.133		AXKITBP1000133			
1" Pipe			EB068P1000	Spring Collet Tailstock		EB65
1" Pipe			EB76P1000	Segmented Collet		EB76
1" Pipe			GB90COP1000	Segmented Collet		TB80 Mandrel
1-1/4" Pipe		3"	AK20DP1250	Tool Set (Includes 4 items:)	030 Mandrel, TB80 Mandrel, EB65, EB76	
			AR84R076P1250	Center Former		
			A2212P1250	Clamp Die		
			A2412R076P1250	Wiper Die		
			A2012P1250	Pressure Die		
1-1/4" Pipe Sch. 5	.065		AXKITSP1250065	Mandrel Flexible STEEL CHROME with Sphere		
1-1/4" Pipe Sch. 10	.109		AXKITSP1250109			
1-1/4" Pipe Sch. 40	.140		AXKITSP1250140			
1-1/4" Pipe Sch. 5	.065		AXKITBP1250065	Mandrel Flexible BRONZE with Sphere		
1-1/4" Pipe Sch. 10	.109		AXKITBP1250109			
1-1/4" Pipe Sch. 40	.140		AXKITBP1250140			
1-1/4" Pipe			EB068P1250	Spring Collet Tailstock		EB65
1-1/4" Pipe			EB76P1250	Segmented Collet		EB76
1-1/4" Pipe			GB90COP1250	Segmented Collet		TB80 Mandrel
1-1/2" Pipe		3"	AK20DP1500	Tool Set (Includes 4 items:)	030 Mandrel, TB80 Mandrel, EB65, EB76	
			AR84R076P1500	Center Former		
			A2212P1500	Clamp Die		
			A2412R076P1500	Wiper Die		
			A2012P1500	Pressure Die		
1-1/2" Pipe Sch. 5	.065		AXKITSP1500065	Mandrel Flexible STEEL CHROME with Sphere		
1-1/2" Pipe Sch. 10	.109		AXKITSP1500109			
1-1/2" Pipe Sch. 40	.145		AXKITSP1500145			
1-1/2" Pipe Sch. 5	.065		AXKITBP1500065	Mandrel Flexible BRONZE with Sphere		
1-1/2" Pipe Sch. 10	.109		AXKITBP1500109			
1-1/2" Pipe Sch. 40	.145		AXKITBP1500145			
1-1/2" Pipe			EB068P1500	Spring Collet Tailstock		EB65
1-1/2" Pipe			EB76P1500	Segmented Collet		EB76
1-1/2" Pipe			GB90COP1500	Segmented Collet		TB80 Mandrel
2" Pipe		5"	AK20DP2000	Tool Set (Includes 4 items:)	030 Mandrel, TB80 Mandrel, EB65, EB76	
			AR133R127P2000	Center Former		
			A2214P2000	Clamp Die		
			A2414R127P2000	Wiper Die		
			A2014P2000	Pressure Die		
2" Pipe Sch. 5	.065		AXKITSP2000065	Mandrel Flexible STEEL CHROME with Sphere		
2" Pipe Sch. 10	.109		AXKITSP2000109			
2" Pipe Sch. 40	.154		AXKITSP2000154			
2" Pipe Sch. 5	.065		AXKITBP2000065	Mandrel Flexible BRONZE with Sphere		
2" Pipe Sch. 10	.109		AXKITBP2000109			
2" Pipe Sch. 40	.154		AXKITBP2000154			
2" Pipe			EB068P2000	Spring Collet Tailstock		EB65
2" Pipe			EB76P2000	Segmented Collet		EB76
2" Pipe			GB90COP2000	Segmented Collet		TB80 Mandrel

Decoding Bend Terms

CLR – Centerline radius. Distance from the center of forming die to centerline of material

DOB – Degree of bend. Number of degrees required in a bend
Sch. – Schedule, or wall thickness of pipe

Ga. – Gauge, or wall thickness of tube
O.D. – Outside diameter
I.D. – Inside diameter

STANDARD TUBE MANDREL TOOLING SETS

MATERIAL	WALL	CLR	ITEM CODE	DESCRIPTION	FITS MODEL
1" Tube		2"	AK20DT1000	Tool Set (Includes 4 items:)	030 Mandrel, TB80 Mandrel, EB65, EB76
			AR53R051T1000	Center Former	
			A223T1000	Clamp Die	
			A243R051T1000	Wiper Die	
			A204T1000	Pressure Die	
1" Tube 16 Ga.	.065		AXKITST1000065	Mandrel Flexible STEEL CHROME with Sphere	
1" Tube 14 Ga.	.083		AXKITST1000083		
1" Tube 11 Ga.	.120		AXKITST1000120		
1" Tube 16 Ga.	.065		AXKITBT1000065	Mandrel Flexible BRONZE with Sphere	
1" Tube 14 Ga.	.083		AXKITBT1000083		
1" Tube 11 Ga.	.120		AXKITBT1000120		
1" Tube			EB068T1000	Spring Collet Tailstock	
1" Tube			EB76T1000	Segmented Collet	EB76
1" Tube			GB90COT1000	Segmented Collet	TB80 Mandrel
1-1/4" Tube		2.5"	AK20DT1250	Tool Set (Includes 4 items:)	030 Mandrel, TB80 Mandrel, EB65, EB76
			AR67R064T1250	Center Former	
			A224T1250	Clamp Die	
			A244R064T1250	Wiper Die	
			A204T1250	Pressure Die	
1-1/4" Tube 16 Ga.	.065		AXKITST1250065	Mandrel Flexible STEEL CHROME with Sphere	
1-1/4" Tube 14 Ga.	.083		AXKITST1250083		
1-1/4" Tube 11 Ga.	.120		AXKITST1250120		
1-1/4" Tube 16 Ga.	.065		AXKITBT1250065	Mandrel Flexible BRONZE with Sphere	
1-1/4" Tube 14 Ga.	.083		AXKITBT1250083		
1-1/4" Tube 11 Ga.	.120		AXKITBT1250120		
1-1/4" Tube			EB068T1250	Spring Collet Tailstock	
1-1/4" Tube			EB76T1250	Segmented Collet	EB76
1-1/4" Tube			GB90COT1250	Segmented Collet	TB80 Mandrel
1-1/2" Tube		3"	AK20DT1500	Tool Set (Includes 4 items:)	030 Mandrel, TB80 Mandrel, EB65, EB76
			AR84R076T1500	Center Former	
			A2211T1500	Clamp Die	
			A2411R076T1500	Wiper Die	
			A2011T1500	Pressure Die	
1-1/2" Tube 16 Ga.	.065		AXKITST1500065	Mandrel Flexible STEEL CHROME with Sphere	
1-1/2" Tube 14 Ga.	.083		AXKITST1500083		
1-1/2" Tube 11 Ga.	.120		AXKITST1500120		
1-1/2" Tube 16 Ga.	.065		AXKITBT1500065	Mandrel Flexible BRONZE with Sphere	
1-1/2" Tube 14 Ga.	.083		AXKITBT1500083		
1-1/2" Tube 11 Ga.	.120		AXKITBT1500120		
1-1/2" Tube			EB068T1500	Spring Collet Tailstock	
1-1/2" Tube			EB76T1500	Segmented Collet	EB76
1-1/2" Tube			GB90COT1500	Segmented Collet	TB80 Mandrel
1-5/8" Tube		3.25"	AK20DT1625	Tool Set (Includes 4 items:)	030 Mandrel, TB80 Mandrel, EB65, EB76
			AR84R082T1625	Center Former	
			A2212T1625	Clamp Die	
			A2412R082T1625	Wiper Die	
			A2012T1625	Pressure Die	
1-5/8" Tube 16 Ga.	.065		AXKITST1625065	Mandrel Flexible STEEL CHROME with Sphere	
1-5/8" Tube 14 Ga.	.083		AXKITST1625083		
1-5/8" Tube 11 Ga.	.120		AXKITST1625120		
1-5/8" Tube 16 Ga.	.065		AXKITBT1625065	Mandrel Flexible BRONZE with Sphere	
1-5/8" Tube 14 Ga.	.083		AXKITBT1625083		
1-5/8" Tube 11 Ga.	.120		AXKITBT1625120		
1-5/8" Tube			EB068T1625	Spring Collet Tailstock	
1-5/8" Tube			EB76T1625	Segmented Collet	EB76
1-5/8" Tube			GB90COT1625	Segmented Collet	TB80 Mandrel

Decoding Bend Terms

CLR – Centerline radius. Distance from the center of forming die to centerline of material

DOB – Degree of bend. Number of degrees required in a bend
Sch. – Schedule, or wall thickness of pipe

Ga. – Gauge, or wall thickness of tube
O.D. – Outside diameter
I.D. – Inside diameter

STANDARD TUBE MANDREL TOOLING SETS

MATERIAL	WALL	CLR	ITEM CODE	DESCRIPTION	FITS MODEL	
1-3/4" Tube		3.5"	AK20DT1750	Tool Set (Includes 4 items:)	030 Mandrel, TB80 Mandrel, EB65, EB76	
			AR100R089T1750	Center Former		
			A2212T1750	Clamp Die		
			A2412R089T1750	Wiper Die		
			A2012T1750	Pressure Die		
1-3/4" Tube 16 Ga.	.065		AXKITST1750065	Mandrel Flexible STEEL CHROME with Sphere		
1-3/4" Tube 14 Ga.	.083		AXKITST1750083			
1-3/4" Tube 11 Ga.	.120		AXKITST1750120			
1-3/4" Tube 16 Ga.	.065		AXKITBT1750065			
1-3/4" Tube 14 Ga.	.083		AXKITBT1750083	Mandrel Flexible BRONZE with Sphere		
1-3/4" Tube 11 Ga.	.120		AXKITBT1750120			
1-3/4" Tube			EB068T1750	Spring Collet Tailstock		EB65
1-3/4" Tube			EB76T1750	Segmented Collet		EB76
1-3/4" Tube			GB90COT1750	Segmented Collet		TB80 Mandrel
2" Tube		4"	AK20DT2000	Tool Set (Includes 4 items:)	030 Mandrel, TB80 Mandrel, EB65, EB76	
			AR110R102T2000	Center Former		
			A2213T2000	Clamp Die		
			A2413R102T2000	Wiper Die		
			A2013T2000	Pressure Die		
2" Tube 16 Ga.	.065		AXKITST2000065	Mandrel Flexible STEEL CHROME with Sphere		
2" Tube 14 Ga.	.083		AXKITST2000083			
2" Tube 11 Ga.	.120		AXKITST2000120			
2" Tube 16 Ga.	.065		AXKITBT2000065			
2" Tube 14 Ga.	.083		AXKITBT2000083	Mandrel Flexible BRONZE with Sphere		
2" Tube 11 Ga.	.120		AXKITBT2000120			
2" Tube			EB068T2000	Spring Collet Tailstock		EB65
2" Tube			EB76T2000	Segmented Collet		EB76
2" Tube			GB90COT2000	Segmented Collet		TB80 Mandrel
2-1/4" Tube		4.5"	AK20DT2250	Tool Set (Includes 4 items:)	030 Mandrel, TB80 Mandrel, EB65, EB76	
			AR121R114T2250	Center Former		
			A2214T2250	Clamp Die		
			A2414R114T2250	Wiper Die		
			A2014T2250	Pressure Die		
2-1/4" Tube 16 Ga.	.065		AXKITST2250065	Mandrel Flexible STEEL CHROME with Sphere		
2-1/4" Tube 14 Ga.	.083		AXKITST2250083			
2-1/4" Tube 11 Ga.	.120		AXKITST2250120			
2-1/4" Tube 16 Ga.	.065		AXKITBT2250065			
2-1/4" Tube 14 Ga.	.083		AXKITBT2250083	Mandrel Flexible BRONZE with Sphere		
2-1/4" Tube 11 Ga.	.120		AXKITBT2250120			
2-1/4" Tube			EB068T2250	Spring Collet Tailstock		EB65
2-1/4" Tube			EB76T2250	Segmented Collet		EB76
2-1/4" Tube			GB90COT2250	Segmented Collet		TB80 Mandrel
2-1/2" Tube		5"	AK20DT2500	Tool Set (Includes 4 items:)	030 Mandrel, TB80 Mandrel, EB65, EB76	
			AR133R127T2500	Center Former		
			A2215T2500	Clamp Die		
			A2415R127T2500	Wiper Die		
			A2015T2500-18	Pressure Die		
2-1/2" Tube 16 Ga.	.065		AXKITST2500065	Mandrel Flexible STEEL CHROME with Sphere		
2-1/2" Tube 14 Ga.	.083		AXKITST2500083			
2-1/2" Tube 11 Ga.	.120		AXKITST2500120			
2-1/2" Tube 16 Ga.	.065		AXKITBT2500065			
2-1/2" Tube 14 Ga.	.083		AXKITBT2500083	Mandrel Flexible BRONZE with Sphere		
2-1/2" Tube 11 Ga.	.120		AXKITBT2500120			
2-1/2" Tube			EB068T2500	Spring Collet Tailstock		EB65
2-1/2" Tube			EB76T2500	Segmented Collet		EB76
2-1/2" Tube			GB90COT2500	Segmented Collet		TB80 Mandrel

Decoding Bend Terms

CLR – Centerline radius. Distance from the center of forming die to centerline of material

DOB – Degree of bend. Number of degrees required in a bend

Sch. – Schedule, or wall thickness of pipe

Ga. – Gauge, or wall thickness of tube

O.D. – Outside diameter

I.D. – Inside diameter

STANDARD TUBE MANDREL TOOLING SETS

MATERIAL	WALL	CLR	ITEM CODE	DESCRIPTION	FITS MODEL
3" Tube		6"	AK20DT3000	Tool Set (Includes 4 items:)	TB80 Mandrel, EB76
			AR178R152T3000	Center Former	
			A2217T3000HR	Clamp Die	
			A2417R152T3000	Wiper Die	
			A2017T3000-18	Pressure Die	
3" Tube 16 Ga.	.065		AXKITST3000065	Mandrel Flexible STEEL CHROME with Sphere	
3" Tube 14 Ga.	.083		AXKITST3000083		
3" Tube 11 Ga.	.120		AXKITST3000120		
3" Tube 16 Ga.	.065		AXKITBT3000065	Mandrel Flexible BRONZE with Sphere	
3" Tube 14 Ga.	.083		AXKITBT3000083		
3" Tube 11 Ga.	.120		AXKITBT3000120		
3" Tube			EB76T3000	Segmented Collet	EB76
3" Tube			GB90COT3000	Segmented Collet	TB80 Mandrel

SQUARE TUBE MANDREL TOOLING SETS

MATERIAL	WALL	CLR	ITEM CODE	DESCRIPTION	FITS MODEL
1" Square Tube		3"	AK30DAT1000	Tool Set (Includes 4 items:)	030 Mandrel, TB80 Mandrel, EB65, EB76
			AR84R076A1000	Center Former	
			A223A1000	Clamp Die	
			A243R076A1000	Wiper Die	
			A203A1000	Pressure Die - Steel	
1" Square Tube	.065		AXKITSA1000065	Mandrel Flexible STEEL CHROME with Sphere	EB65
1" Square Tube	.120		AXKITSA1000120	Mandrel Flexible STEEL CHROME with Sphere	
1" Square Tube			EB068A1000	Spring Collet Tailstock	EB76
1" Square Tube			EB76A1000	Segmented Collet	TB80 Mandrel
1" Square Tube			GB90COA1000	Segmented Collet	
1-1/2" Square Tube		4.4"	AK30DAT1500	Tool Set (Includes 4 items:)	030 Mandrel, TB80 Mandrel, EB65, EB76
			AR121R114A1500	Center Former	
			A2211A1500	Clamp Die	
			A2411R114A1500	Wiper Die	
			A2011A1500	Pressure Die - Steel	
1-1/2" Square Tube	.065		AXKITSA1500065	Mandrel Flexible STEEL CHROME with Sphere	EB65
1-1/2" Square Tube	.120		AXKITSA1500120	Mandrel Flexible STEEL CHROME with Sphere	
1-1/2" Square Tube			EB068A1500	Spring Collet Tailstock	EB76
1-1/2" Square Tube			EB76A1500	Segmented Collet	TB80 Mandrel
1-1/2" Square Tube			GB90COA1500	Segmented Collet	
2" Square Tube		6"	AK30DAT2000	Tool Set (Includes 4 items:)	030 Mandrel, TB80 Mandrel, EB65, EB76
			AR178R152A2000	Center Former	
			A2213A2000	Clamp Die	
			A2413R152A2000	Wiper Die	
			A2013A2000	Pressure Die - Steel	
2" Square Tube	.065		AXKITSA2000065	Mandrel Flexible STEEL CHROME with Sphere	EB65
2" Square Tube	.120		AXKITSA2000120	Mandrel Flexible STEEL CHROME with Sphere	
2" Square Tube			EB068A2000	Spring Collet Tailstock	EB76
2" Square Tube			EB76A2000	Segmented Collet	TB80 Mandrel
2" Square Tube			GB90COA2000	Segmented Collet	

Decoding Bend Terms

CLR – Centerline radius. Distance from the center of forming die to centerline of material

DOB – Degree of bend. Number of degrees required in a bend

Sch. – Schedule, or wall thickness of pipe

Ga. – Gauge, or wall thickness of tube

O.D. – Outside diameter

I.D. – Inside diameter

CuNi CLASS 200 MANDREL TOOLING SETS

MATERIAL	WALL	CLR	ITEM CODE	DESCRIPTION	FITS MODEL
1" Pipe		4"	AK30DP1000	Tool Set (Includes 4 items:)	030 Mandrel, TB80 Mandrel, EB65, EB76
			AR100R100P1000	Center Former	
			A224P1000	Clamp Die	
			A244R100P1000	Wiper Die	
			A201P1000	Pressure Die - Polymer	
1" Pipe Sch. 5	.070		AXKITCUNIP1000070	Mandrel Flexible STEEL CHROME with Sphere	
1" Pipe			EB068P1000	Spring Collet Tailstock	EB65
1" Pipe			EB76P1000	Segmented Collet	EB76
1" Pipe			GB90COP1000	Segmented Collet	TB80 Mandrel
1-1/4" Pipe		5"	AK30DP1250	Tool Set (Includes 4 items:)	030 Mandrel, TB80 Mandrel, EB65, EB76
			AR133R127P1250	Center Former	
			A2212P1250	Clamp Die	
			A2412R127P1250	Wiper Die	
			A201P2P1250-18	Pressure Die - Polymer	
1-1/4" Pipe Sch. 5	.072		AXKITCUNIP1250072	Mandrel Flexible STEEL CHROME with Sphere	
1-1/4" Pipe			EB068P1250	Spring Collet Tailstock	EB65
1-1/4" Pipe			EB76P1250	Segmented Collet	EB76
1-1/4" Pipe			GB90COP1250	Segmented Collet	TB80 Mandrel
1-1/2" Pipe		6"	AK30DP1500	Tool Set (Includes 4 items:)	030 Mandrel, TB80 Mandrel, EB65, EB76
			AR178R152P1500	Center Former	
			A2212P1500	Clamp Die	
			A2412R152P1500	Wiper Die	
			A201P1500-18	Pressure Die - Polymer	
1-1/2" Pipe Sch. 5	.072		AXKITCUNIP1500072	Mandrel Flexible STEEL CHROME with Sphere	
1-1/2" Pipe			EB068P1500	Spring Collet Tailstock	EB65
1-1/2" Pipe			EB76P1500	Segmented Collet	EB76
1-1/2" Pipe			GB90COP1500	Segmented Collet	TB80 Mandrel
2" Pipe		7.125"	AK30DP2000	Tool Set (Includes 4 items:)	TB80 Mandrel, EB76
			AR200R180P2000	Center Former	
			A2214P2000	Clamp Die	
			A2414R180P2000	Wiper Die	
			A201P4P2000-18	Pressure Die - Polymer	
2" Pipe Sch. 5	.083		AXKITCUNIP2000083	Mandrel Flexible STEEL CHROME with Sphere	
2" Pipe			EB76P2000	Segmented Collet	EB76
2" Pipe			GB90COP2000	Segmented Collet	TB80 Mandrel
2-1/2" Pipe		8.625"	AK30DP2500	Tool Set (Includes 4 items:)	TB80 Mandrel, EB76
			EBDR219P2500	Center Former	
			A2216P2500	Clamp Die	
			A241/6R219P2500	Wiper Die	
			A201P6P2500-18	Pressure Die - Polymer	
2-1/2" Pipe Sch. 5	.083		AXKITCUNIP2500083	Mandrel Flexible STEEL CHROME with Sphere	
2-1/2" Pipe			EB76P2500	Segmented Collet	EB76
2-1/2" Pipe			GB90COP2500	Segmented Collet	TB80 Mandrel

Decoding Bend Terms

CLR – Centerline radius. Distance from the center of forming die to centerline of material

DOB – Degree of bend. Number of degrees required in a bend

Sch. – Schedule, or wall thickness of pipe

Ga. – Gauge, or wall thickness of tube

O.D. – Outside diameter

I.D. – Inside diameter

CuNi Size Chart

IPS	OD	90/10 70/30	70/30			
		CL 200 Wall	CL 700 Wall	CL 1650 Wall	CL 3300 Wall	CL 6000 Wall
1"	1.315	0.065	0.095	0.095	0.180	0.300
1-1/4"	1.660	0.072	0.095	0.120	0.220	0.380
1-1/2"	1.900	0.072	0.109	0.134	0.250	0.425
2"	2.375	0.083	0.120	0.165	0.340	0.520
2-1/2"	2.875	0.083	0.134	0.203	0.380	

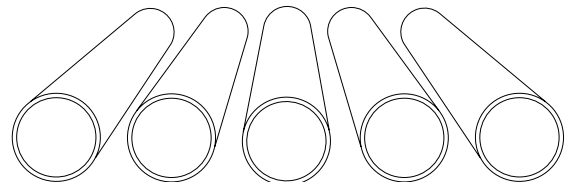

FACTORY TRAINING INCLUDED WITH MACHINE PURCHASE

Machine Operation Training 1-1/2 days completed at CML USA, Inc., 3100 Research Parkway, Davenport Iowa.

Includes review of machine components and operation, display functions, tooling selection, material review, proper mounting of tooling, tooling adjustments, introduction to programming, creating and storing program(s) to display, how to produce parts, standard required maintenance, and necessary connections, lubricates, fluids. General safety practices when using Ercolina machinery.

Factory training includes hotel accommodations for up to two nights with lunch provided daily. Customer must provide prints and sample material to CML USA, Inc. prior to training or CML will produce parts using the following material: A53 Grade A 1-1/4" schedule 40 pipe or 1-1/2" OD tube mild steel .120 wall.





MATERIAL OVERVIEW COMMON TUBE AND PIPE

Pipe and tube are manufactured from a variety of metals are suitable for bending. However, different pipe materials have different physical properties which influence the bend. For example, copper is malleable and ready to bend at room temperature, whereas stainless steel requires a much greater effort to bend. Not only does pipe material influence the ease of bending, but it also influences how readily a pipe will take the desired shape or be damaged during the bending process. Most buyers don't even ask the question is this material suited for bending. Always start with the material and confirm it is acceptable for bending.

Carbon steel

The term carbon steel is often used to indicate steel that is not stainless steel, and is one of the most commonly bent materials. It is a strong, reliable component for construction (Figure 2) and OEM (original equipment manufacturer) applications. Carbon steel is available in different grades, offering various options in machining, bending, and wear resistance.

Mild steel

Mild steel is a commercial term that means low-carbon steel. It contains 0.04 - 0.3% carbon and therefore is more malleable and ductile. Ductility decreases as the carbon percentage in the steel increases. All machines are rated on mild steel capacity, bending higher tensile materials must be factored in sizing the machine model. Higher tensile strength materials require larger machines.

Alloy steel

Typical pipe material tensile strengths:

Grade A 48000 PSI (Machine rated for Grade A)

Grade B 60000 PSI

Grade C 70000 PSI

Two popular steel alloys are AISI 1018 and AISI 4140. The last two digits of each number indicate the percentage of carbon in the alloy: 1018 has 0.18% carbon and 4140 has 0.40% carbon. This means that 1018 is a mild steel and 4140 is a medium-grade carbon steel. AISI 1080 can be cold bended and AISI 4140 should be heat treated before bending.

Stainless steel

Material tensile strengths:

304 SS 73200 PSI

Different grades of stainless-steel range in carbon content from low-grade to high-grade (approximately 1% carbon content), but are differentiated from carbon steel by their high chromium content (minimum 10.5%). This high chromium content is what protects stainless steel from corrosion and rust. Of the different types of stainless steel, 300-series, specifically 304 stainless steel is the most popular for bending due to its ductility. However, at large diameters, stainless steel is very difficult to bend manually. A mandrel bending machine is typically used in this case.

Aluminum

Aluminum is lightweight, and the material requires specialized skills and forming processes to prevent material cracking. However, the bending properties vary according to the different grades of aluminum used. 6061 aluminum material is hard to bend, and cracking is pretty common. Cold bending always weakens the material. Proper bending can be by using T0 temper material that is new from mill, or annealing aluminum first. 3003 aluminum is the best for bending due to its midrange strength and high elongation. It can be cold bent, and has a high difference between tensile strength and yield strength. This means it can be permanently deformed, in other words bent, a great deal before breaking. 5052 aluminum 5052 aluminum is almost as good for bending as 3003 aluminum, but has slightly less elongation. However, when heated, its formability improves past that of 3003 aluminum. Aluminum is commonly used in transportation and storage tanks. Always use the largest radius possible when bending aluminum to avoid breaking the material.

Copper Tube

Both annealed tube and hard drawn tube can be bent with the appropriate machine and tooling. Material grade, wall thickness and minimum CLR must all be considered before bending.

MANDREL BENDING TROUBLESHOOTING

Problem	Probable Cause	Solution
Hump at the end of outside bend	Mandrel too far forward	Relocate mandrel back
Excessive vibration during bend	Mandrel too far forward	Relocate mandrel back
Mandrel advances, former will not rotate to bend	Mandrel limit switches out of adjustment. Switches are located at the top rear of mandrel table, underneath removable blue cover	Position switches correctly Display should read as follows: Mandrel retracted 100mm Mandrel advanced 0mm Mandrel Between switches 50mm
Mandrel will not retract prior to end of bend cycle (Machine program light is light red)	Need to retract mandrel prior to end of bend cycle	Depress and hold return foot pedal switch for five seconds. Program light should go out and allow mandrel function button to retract manual.
Oval tube	Mandrel too far back	Relocate mandrel back
Wrinkles on inside	Mandrel too far back	Relocate mandrel back
Wrinkles on inside	Mandrel too small	Correct size
Wrinkles on inside	Low pressure die pressure	Increase pressure
Wrinkles on inside	Wrong mandrel end	Adjust to suite material
Wrinkles on inside bend, scratches on tube surface	Low clamping pressure	Increase pressure
Tool marks tube	Oversize tubing	Correct size
Wrinkles on inside of bend with thin wall tubes	Wiper die not positioned well or worn	Adjust or replace wiper die

Common Rotary Draw Bending Issues and their Solutions

When it comes to making a perfect bend, several factors come into play:

- Determine that the bender you will be using is operating properly.
- Make sure clamping and unclamping of dies, rotation of swing arm, and extracting of mandrel are all occurring in the proper sequence.
- Make sure the tube you will be using is clean, both inside and outside.
- Check the tooling, making sure it is clean, burr free and compatible with the tube to be bent.
- Confirm that the mandrel is the required distance past the tangent.



- 1 Hump at end of bend.**
Solution:
✓ Relocate mandrel back from tangent until bump is barely visible (this is a good system to find the best location for a mandrel.)

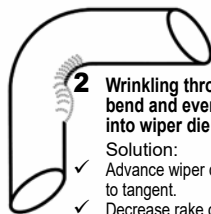

- 2 Wrinkling throughout bend and even extending into wiper die areas.**
Solution:
✓ Advance wiper die closer to tangent.
✓ Decrease rake of wiper die.
✓ Wiper worn out - have replaced.

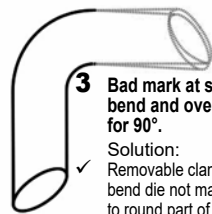

- 3 Bad mark at start of bend and over bend for 90°.**
Solution:
✓ Removable clamping portion of bend die not matched properly to round part of bend die.
✓ Clamping portion of bend die not parallel to key way.

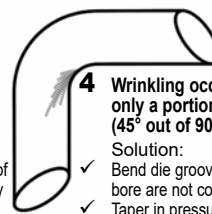

- 4 Wrinkling occurring for only a portion of the bend (45° out of 90°.)**
Solution:
✓ Bend die groove and counter-bore are not concentric.
✓ Taper in pressure die (from bottom of tube groove to back of die.)



- 5 Wrinkling throughout bend area with wiper and mandrel in known proper position.**
Solution:
✓ Check for undersized mandrel.
✓ Increase pressure die force only after checking wiper fit and mandrel location.

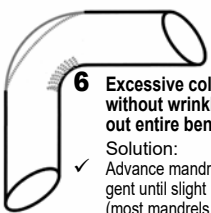

- 6 Excessive collapse with or without wrinkling throughout entire bend.**
Solution:
✓ Advance mandrel toward tangent until slight hump occurs (most mandrels must project somewhat past tangent.)

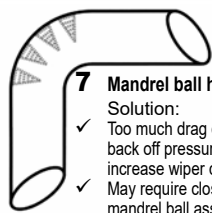

- 7 Mandrel ball humps.**
Solution:
✓ Too much drag on tube; back off pressure die force - increase wiper die rake.
✓ May require closer pitch mandrel ball assembly.
✓ Tubing material too soft.

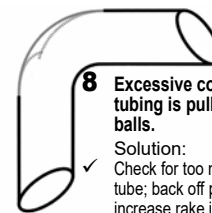

- 8 Excessive collapse after tubing is pulled off mandrel balls.**
Solution:
✓ Check for too much drag on tube; back off pressure die force, increase rake in wiper die, etc.
✓ Increase mandrel support, change from a plug to a one ball, from a 2 ball to a 3 ball mandrel, etc.



- 9 Heavy wrinkle through bend area only and linear scratches in grip area indicating slippage in clamp section.**
Solution:
✓ Reduce pressure die force.
✓ Check location (and lube) of mandrel and wiper die.
✓ Increase pressure on clamp die.
✓ Use serration, knurling or carbide spray in clamp area.

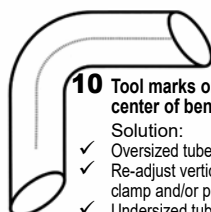

- 10 Tool marks on center of bend.**
Solution:
✓ Oversized tube.
✓ Re-adjust vertical alignment of clamp and/or pressure die.
✓ Undersized tube groove in bend die.

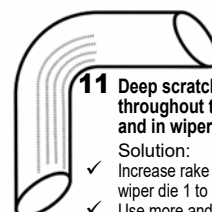

- 11 Deep scratches throughout the bend and in wiper die area.**
Solution:
✓ Increase rake or relief in wiper die 1 to 2 degrees.
✓ Use more and/or better lubrication.
✓ Galled tube groove in wiper die. Recut wiper die.

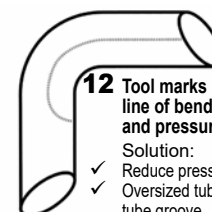

- 12 Tool marks on center line of bend in clamp and pressure die area.**
Solution:
✓ Reduce pressure die force.
✓ Oversized tube or undersized tube groove.



Mandrel Nose Problems:

Ovality (i.e., general deformation of the tube's cross-section) is excessive. Check if the mandrel nose is undersized or not placed deep enough into the bend. If undersized, a temporary fix may be to advance it deeper into the bend. However, optimal bending will require a new mandrel made to the correct nose diameter.

The inside radius buckles. Check if the mandrel nose is placed behind the line of tangency.

The outside radius collapses. Check if the mandrel nose is placed behind the line of tangency.

A hump or humps form on the outside radius. This is usually not because the mandrel nose is too deep into the bend, but because there is excessive drag or insufficient assist from the pressure die. See below for details. However, if you do suspect the mandrel nose is the problem, check the depth of its placement

Drag is excessive. This is not a defect but an immediate cause of many defects. Too much direct pressure die pressure is usually the culprit, however, an oversized mandrel nose can be the problem.

Direct Pressure Problems:

Continuous wrinkling of the inside radius. If the entire arc of the inside radius is wrinkled, this indicates that the direct pressure die pressure is too low. Note that this defect is distinct from a single hump or a small series of humps forming on the inside radius at the end of the bend. This type of wrinkling is associated with the wiper die.

Excessive flattening of the outside radius. A very common problem that results from too much direct pressure die pressure. In effect, the pressure die is clamping on the tube at the point of bend causing the outside radius to stretch and flattening between the pressure die and the clamp die. Reduce the pressure.

If the mandrel nose is properly placed and the direct pressure is correct and flattening is still too much, then the assist pressure should be increased.

Wiper Tip Problems:

A hump or humps form on the inside radius at the end of the bend. The role of the wiper is limited. Humps are the only problem the wiper is designed to solve. Humps only occur if the wiper is not raked correctly or is worn out. Decreasing the rake will eliminate this problem.

Assist Pressure Problems:

Excessive flattening of the outside radius. If excess direct pressure has been eliminated as a source of this defect

A hump or humps on the outside radius. Respond to this in the same way as to excessive flattening if mandrel nose placement is correct.

Excessive wall thinning. If ovality and flattening are under control, then increase the assist pressure.

Other Sources of Problems:

While the set-up is most often the source of a bending problem, other factors may include:

- The machine is not applying pressure consistently.
- The machine is not lubricating the tooling properly.
- The tools are worn out.
- The working surfaces of the tools are mismatched or dimensionally incorrect for the bending application.
- The tubing material is undersized, oversized, or the wrong wall thickness.
- The tubing material is too hard or too soft.

GIGA BENDER CNC MANDREL BENDERS



Giga Bender CNC Mandrel Benders Table of Contents

- GB100SCNC Giga Bender.....58-59
- GB130/GB200 Giga Bender.....60-61
- Giga Bender Line information.....62-65
- Machine axes66
- KST system (patented).....67
- KST selection guide68
- Giga Bender features for bending heavy tube and profiles69
- Giga Bender tooling line70
- Giga Bender KST Clamping Kit.....71
- QR codes to view mandrel videos.....72



GIGA BENDER CNC MANDREL BENDERS





GB100SCNC Giga Bender

CNC Mandrel Machine



Heavy Steel Structure Provides Rigid Platform and Minimizes Vibration

FEATURES

- GB100SCNC control of 7 axis with Windows controller
- Ideal for industrial mandrel bending of tube, pipe, square and rectangular profiles to center line radius as small as 1.5D
- Programmable bend angles with independent material springback setting for each bend
- Programmable auto mandrel positioning allows operator to optimize extraction for improved bend quality
- Adjustable clamping, pressure die and boost movements with manual override
- Digital encoders on each axis
- Programmable tail stock interference zone monitors position and avoids workhead collision
- Large capacity hydraulic reservoir with automatic cooling system
- Standard hydraulic ports accept Ercolina patented (KST) clam shell clamp system

GB100SCNC Capacities & Specifications

Giga Bender Model	GB100SCNCV2 (CNC)
Max. Tube Capacity – Mild Steel	4 ³ / ₄ " (.187 wall) <i>KST std.</i>
Stainless	4 ³ / ₄ " (.187 wall) <i>KST std.</i>
Square Tube	4" (.125 wall) <i>KST std.</i>
Max. Pipe Capacity – A36	3" Sch. 40
Max. Bending Radius	16"
Min. Bending Radius	1.5 x Ø
Max. Material Length – Standard table	13'
Hydraulic Clamping	(KST) Clam Shell
(C Axis) Rotation / Bend Angle	CCW / 0° to 180°
(B Axis) Bend Plane Rotation (Y1 Axis) Distance Between Bends	Auto positioning with digital display
(X2) Pressure Die Linear Travel (Y2) Pressure Die In-feed	Programmable with digital readout
Program Storage	Unlimited with USB
Hydraulic Reservoir	40 gal.
Motor (horse power @ 480V)	30
Power	Three Phase 480V
Dimensions (Height x Width x Length)	55" x 51" x 298"
Weight (Dry)	7,200 lbs.

Contact CML USA for complete technical specifications.

All capacities based on mild grade materials;
heavy wall and high tensile materials reduce machine capacity.

- Hand-held remote bending control, certified class 3 safety electrical components UL, CSA and CE approved
- Standard programmable internal mandrel lubrication
- Accepts YBC and XYZ input values
- Y - Auto Feeding Hydraulic (CNC only)
- B - Auto Feeding Hydraulic (CNC only)
- C - Bending Hydraulic (NC or CNC)

**Product
Demonstrations
Available on Website**

**NEED ADDITIONAL HELP?
CONTACT ERCOLINA:**

563.391.7700

info@ercolina-usa.com



GB130/GB200 Giga Bender

Fully Automated CNC Mandrel Machines



Heavy Steel Structure Provides Rigid Platform and Minimizes Vibration

FEATURES

- Interactive PLC touch screen offers easy access to auto and manual operating modes, system diagnostics and multiple language capability
- Programmable bend angles with independent material springback setting for each bend
- Programmable auto mandrel positioning allows operator to optimize extraction for improved bend quality
- Programmable clamping, pressure die and boost movements with manual override
- Precision encoders on each axis
- Programmable tail stock interference zone monitors position and eliminates workhead collision
- High capacity hydraulic reservoir with automatic cooling system
- Hand-held remote bending control, certified class 3 safety and all electrical components UL, CSA and CE approved
- Standard programmable internal mandrel lubrication

GB130/GB200 Capacities & Specifications

Model	Giga Bender 130	Giga Bender 200
Max. Tube Capacity – Mild Steel	5" (.196 wall)	6½" (.187 wall)
Stainless	5" (.150 wall)	6" (.187 wall)
Square Tube	4" (.160 wall)	4" (.187 wall)
Max. Pipe Capacity	4" Sch. 40	6" Sch. 40
Max. Bending Radius	18"	20"
Min. Bending Radius	3.125"	4.7"
Max. Tube Inside Carriage	5"	6½"
Max. Length Through Carriage	236"	236"
Max. Length in Carriage	177"	177"
Interactive Control	10" touch screen color	10" touch screen color
Number of Programs	Unlimited w/USB	Unlimited w/USB
Bend Direction	CCW	CCW
"Y" Axis Speed (ft/min)	164	118
"B" Rotation Speed (RPM)	30	20
"C" Bend Speed (RPM)	2	.6
Repeatability "Y" Axis	± .2mm	± .2mm
"C" Axis	± .5mm	± .5mm
Power	Three Phase 480V	Three Phase 480V
Dimensions (Height x Width x Length)	71" x 75" x 319"	77" x 91" x 339"
Weight (Dry)	18,000 lbs.	30,000 lbs.

Contact CML USA for complete technical specifications.

All capacities based on mild grade materials;
heavy wall and high tensile materials reduce machine capacity.

- Machine frame standard compression design
- Accepts YBC and XYZ input values
- Y - Feeding Hydraulic
- B - Feeding Hydraulic
- C - Bending Hydraulic CNC

**Product
Demonstrations
Available on Website**

**NEED ADDITIONAL HELP?
CONTACT ERCOLINA:**

563.391.7700

info@ercolina-usa.com



Ercolina Giga Bender's Improved Design

Ercolina benders are more rugged and versatile than traditional outdated "swing arm" technology. Bending axis positioned directly beneath pressure die, eliminates the need for a tie bar and prevents material slippage. Bending force exerted by the spindle is resisted by pressure die which is monitored and continuously adjusted automatically for consistent pressure throughout the bend cycle.

Giga Bender series internal design incorporates large spindle and bearing diameters ensuring the greatest rigidity. Ercolina benders are engineered using today's state of the art technology and machine tool standards.

Capacities rated in material size as well as section modulus enable the customer to determine the machine's true capacity for application. If you are considering purchasing a heavy-duty tube, pipe or profile mandrel-bending machine please consider the Ercolina advantage.



The Bend Head

The bend head moves transversally to the machine axis for bending radius adjustment. This concept is very useful for tooling set up when adjusting for different bend radius. CML International developed a new concept of bend head horizontal slide (patented in 2007), that allows a very heavy bend head to move accurately with ease. The bend head designed for KST Clamping is compact, rigid and offers a high torque of bend. It's manufactured entirely in spheroidal cast iron GS500 which provides stability and absorbs vibration during the bending process.

Traditional Swing Arm Clamping Difficulties

Swing arm benders clamp die are mounted on a carrier resting on a slide built into the top of a "swing-arm". The arm assembly "swings" with the bend die's rotation. The clamp die, upon closure inherently induces a massive offset load onto the bend die. This can produce tilt of the bend die. As the bend die rotates, this tilt results in a continuously varying out-of-plane relationship between the bend die and both the pressure die and wiper die. The older the machine and tooling, the worse the condition becomes. The bend die moves and tilts under clamp loads, the upper portions of the clamp surface actually pull away from the workpiece, resulting in a reduced clamping grip.

Because extremely high clamping and bending forces are required in bending large workpieces, this tilting phenomenon necessitates the use of overhead tie bars, center-posts, multiple hold-down bolt patterns, and flange-mounted bend dies on swing arm benders.

Toggle type clamp closure mechanisms used on most swing arm benders generate indeterminate excessive clamping force at its dead-center position before reaching the over-dead-center locked-up position. With hydraulically actuated mechanical device clamping, it is not possible to use hydraulic pressure gauges to measure true clamping.

As bending machines become larger, the swing arm assembly becomes disproportionately more massive in order to impose the necessary clamping forces and to accommodate up to 5 X D bend dies. The main beam of a swing arm bender is at right angles to the pressure die slide. These benders use the immovable main frame for functions which are related to the variable centerline location of the workpiece - functions such as 3-axis carriage ways support and mandrel extractor mounting. Heavy loads imposed by larger workpieces are carried through unnecessarily complex



and/or indirect mechanisms. In addition, the arm and clamp become interference obstacles when the pipe is being advanced between bends. This difficulty can only be resolved by either a drop-away clamp mechanism or a separately pivoted coaxial swing arm and main shaft – each more complex, and weaker, representing compromises for outdated machine design. Eliminating clamp interference by mechanical means increases maintenance costs and decreases reliability.

C Axis Design

C Axis movement uses single two speed hydraulic cylinder to operate bend and return functions, simple to regulate, minimizes bending head dimensions, reducing the overall footprint of machine. C Axis driven with two chains directly connected to axis eliminates sprockets and play in axis. Return bending pressure is controlled to 50 Bar for safety. Bend head axis moves to adjust centerline, maintains axis alignment with mandrel carriage. Bend head axis adjustable for centerline radius of former maintains axis alignment. CNC7 models have motorized axis alignment for bending head alignment and workpiece loading and unloading. Powered centerline radius adjustment of the bending head allows the mandrel table to remain stationary and rigid. All cast parts are certified GS500 steel Spheroid design. Multiple design improvements and patents eliminate dated mechanical systems and mass.

Choosing the Proper Carriage

Less expensive and poorly designed benders offer no carriage or only manually operated models. Ercolina's powered indexing carriage advances and rotates the workpiece between bends. Primarily the carriage is a material handling mechanism positioning the workpiece for each bend just as accurately as the carriage of a CNC bender. Standard with positioning tailstock for controlling Y and B movements meaning Distance Between Bends (DBB) and Plane of Bend (POB) includes DRO standard. Tailstock with Hydraulic clamping and split collet material capacity securely supports material. The most important benefits of the powered carriage on a larger bender are powered loading, positioning, and unloading of heavy workpiece, especially when the pipe or tube must be drawn many feet over a snug fitting mandrel. The basic bender is complemented by the carriage-mandrel beam, without design compromises to either. Because the main beam and drive cylinder is under the pressure die slide,

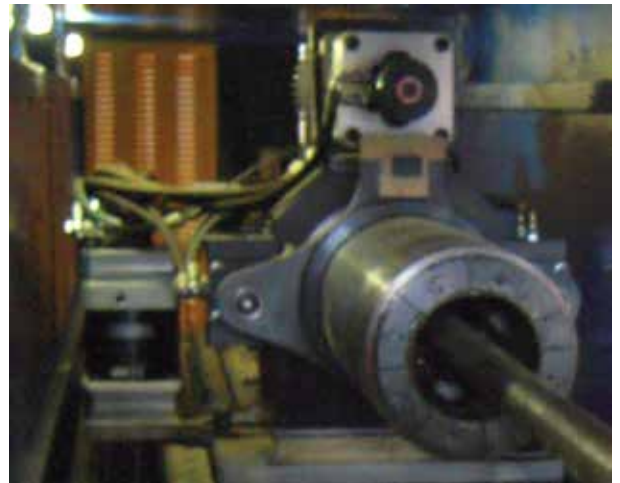

rather than under the mandrel beam, as in most benders, the carriage is designed to accommodate the centerline height of the bender's tooling, not vice versa. When a carriage is added to a traditional swing arm bender, the centerline height of the bend die must be elevated to accommodate the carriage collet's height above the main beam. This extra tooling height compounds the risk of bend die tilt. GB series axis travel and load length is not restricted by the bender's main beam length and does not require an extended frame. The carriage rides on precision ground ways for smooth movement for distance between bends, driven by a powerful hydraulic motor through a rack and pinion. Carriage chuck rotation plane-of-bend movement is also hydraulically driven. The carriage provides safe, accurate, one-man, powered positioning for distance-between-bends and plane-of-bend movements. Positioning is achieved by use of digital encoders with digital read out for each axis. The inside dimension of the carriage allows tube to pass through enabling recapture cycle, increasing machine length capacity. This cycle is selected automatically from the control. A radial slide on the Y1 axis allows the carriage to move out of the machine axis. During bend cycle if radial movement occurs due to a tube movement the linear axis guides are not under pressure, rather the carriage moves. A powered carriage eliminates the need for additional operators, reducing labor cost and improving accuracy. Powered carriage options are ideal for multiple bend applications requiring greater accuracy. Hydraulic oil cooler operates under variable temperature conditions.

KST Clam Shell Material Clamping Advantages

Patented Ercolina KST clamp system mounts directly over C bending axis, eliminating dated swing arm and tie bar systems. Simple tooling installation of clamp and pressure die. Clam shell clamping system uses two double acting cylinders, one for positioning and one for clamping, creating direct proportional pressure (Patented). No tie bar required, tooling maintains consistent balance of pressure. No clamp-pressure induced bend die tilt - even when bending the heaviest or most "critical" workpieces. Built-in clamp alignment in the matching mounting surfaces of the



Giga Bender Line

clamp mechanism and bend die assure that no vertical or horizontal clamp set-up adjustment is required. Therefore, tool changing is faster and easier. The clamp opens upwards, eliminating interference with the forward feed of the bent workpiece. Clamping forces are self contained - not carried through the die mount, the spindle, or any other part of the machine. Thus, there is never any bend-die tilt caused by clamping forces. Tooling remains properly aligned because the bend die rotates in a level plane throughout the bend. Machine and tooling maintenance are reduced. There are no swing arm slides or toggle linkages to sear or break, and less stress and wear on the tooling. Overhead clamping is safer. Dangerous "pinch points" between the swing arm and pressure die arm are eliminated. Bender operator has direct control of the clamping forces. They are easily read on a pressure gauge and easily set with a relief valve, assuring consistent, accurate set-ups.



Mandrel Functions

Standard programmable anticipated mandrel extraction. Tool free installation and adjustment of mandrel rod. Twenty-foot over-mandrel load length and carriage travel available accepts full pipe lengths in one continuous motion with no hitch feeding. Mandrel lubricator system designed to pump heavy lubricant through hollow mandrel rod out through holes in side of mandrel throughout the bend cycle as needed. Lubricator is automatically controlled with touch screen and is included with all Giga Bender models.

Mandrel Retract System

Cylinder controls mandrel support rod with position maintained by encoder, eliminating any manual switch regulation. Mandrel in and out positions are adjustable from software on the control. Anticipated mandrel retract is also programmable from the software to improve the bend quality. Mandrel in position is accessible and adjusted outside the machine frame. Position can be regulated any time during initial setup by turning a nut. Other advantages for the GB mandrel system include faster set up, more rigidity, quick tooling change over, mandrel rod can be fixed or can rotate with the profile.



Pressure Die System

Patented feature offers programmable pressure die with auto recapture during bend cycle to 180 degrees. Operator enters pressure die length and machine auto calculates and performs required cycle movements. Pressure die cylinder automatically compensates and adjusts pressure throughout the bend cycle as tube dimensions change. System offers more clearance for tube loading and unloading, adjustable speed control of linear booster. Compact machine design with reduced pressure die length greatly reduces material waste at end of bend. Programmable inward and outward pressure die positioning.

Booster Feature

Involves a continuous push-force applied directly to the workpiece through a booster clamp. To achieve maximum booster effect, the booster cylinder and its mounting system must be able to exert a sufficient load to bring the workpiece close to compressive yield. Booster clamp is mounted directly on the rear of the pressure die, providing continuous column strength reinforcement of the workpiece under high booster loads.



Overall Structure

All mandrel bending machines have a frame. The Ercolina GB series frame maintains the mandrel in axial position during the bend cycle. Force is high, approaching 15,000kg, when bending 6" tube. The bender's structure must maintain the mandrel in position as this occurs. Structure on a mandrel machine works in flexion, If the frame is not stable enough, the mandrel position changes and moves forward to the bend axis, the traction effort increases and the frame reacts pulling the mandrel back to the initial position creating vibration. To stabilize the mandrel position, older bending machines require larger, heavier frames increasing the machine size and weight. This style of machine requires it to be fixed to shop floor. Flexion on frame will still exist. The structure for a 5" tube of 15,000t working in flexion moves around 1/2" inch when bending. CML's patent uses a frame working in compression. This tunnel structure increased stability more than 50 times with less weight. The tube axis is located inside the structure, unlike conventional bending machines which are outside. The structure supports pure compression with more stability of the machine, higher bending accuracy, stability for components and safer bending.

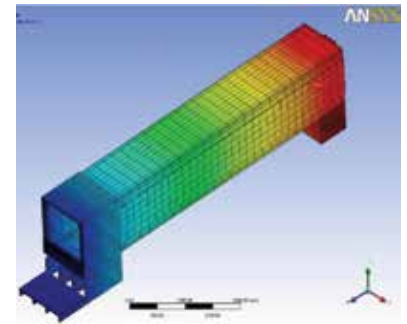

Operator Control

Industrial PC with 17" touch screen is located in movable separate tower with hand held Sic safety control. Windows 10® operating system with easy storage of programs to hard drive or external USB Key or via network. Automatic and manual cycle with individual axis control manual override of Clamp, Pressure Die, Boost, Mandrel, and Clamp release function. Programming capable of Cartesian or polar coordinates to tangent or CLR dimensions. Programs in YBC and XYZ with auto convert to LRA. Accepts XYZ cad values with manual input. Displays five axis positions in Absolute or Incremental readout value. Inch and Metric programming and display of bend angle with individual springback settings for all programmed bends. Tooling profile setup page automatically creates bending program from XYZ coordinates. Calculates material length required for application. Machine load requirement based on material specs. Program calculates material stretch and theoretical wall thinning percentage minimizing setup. Full machine function diagnostics, machine parameters data page with 500 programmed values and functions and complete alarm list with definitive alerts. Updateable machine software with USB (requires optional importation software).

Numerical Control

Virtual simulation with three-dimensional visualization tube application anti-collision system to view bending process and movement of tube, machine, and tube to floor restrictions. Other features include integrated diagnostics, multi-language interface, tooling database for easy recall, and automate calculation of material springback and anticipated mandrel movement programming.



Machine Axes

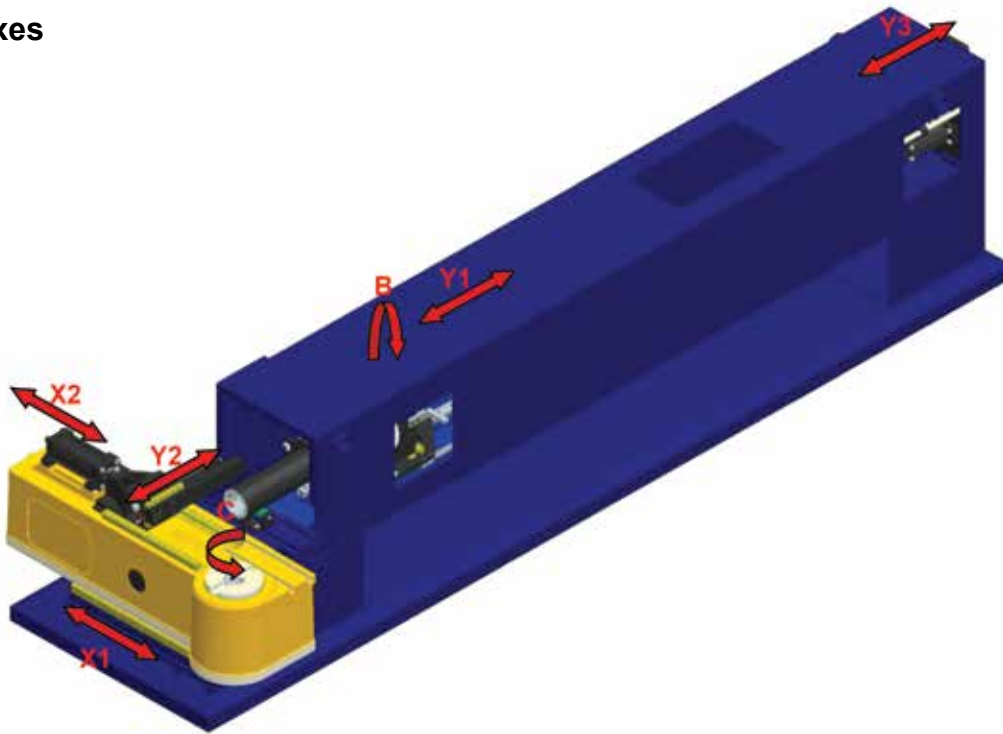

#	Axis	Name	Unit	Repeat	Max Speed
1	Y1	Linear (DBB)	mm/inch	(+/-) 0.1mm	650 mm/s
2	B	Rotation (POB)	°	(+/-) 0.1°	100 °/s
3	C	Angle (DOB)	°	(+/-) 0.1°	4.9 °/s
4	X1	Horizontal head (CLR)	mm/inch	(+/-) 0.1mm	640 mm/s
5	X2	Pressure die	mm/inch	(+/-) 0.5mm	160 mm/s
6	Y2	Booster	mm/inch	(+/-) 0.5mm	410 mm/s
7	Y3	Mandrel	mm/inch	(+/-) 0.5mm	434 mm/s

KST system (patented)

One small cylinder moves clamp from open position to pre-close position.
 The main cylinder, while closing, is locked by gravity on the structure and acts on clamp to close tube.
 Clamping stroke is short.
 Action on clamp cylinder uses longer lever increasing clamping force.
 Compact for maximum efficiency.



CML kit KST 4

KST:

No bend arm.
 Bend die is directly fixed on bend shaft.
 No tooling set up, fast tool changing.
 Clamping effort is directly proportional to cylinder pressure.
 System compact, high efficiency.
 Use shorter clamp (reduce distance between bends).

Dimensions

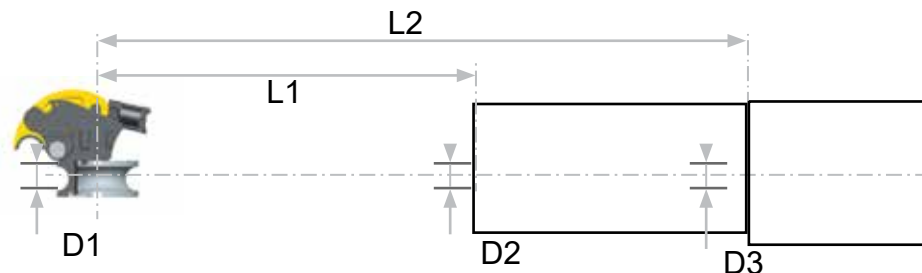

L1	in	178.5
L2	in	252
D1	in	7
D2	in	6.9
D3	in	7.3

Power supply:	kW	35
Hydraulic oil capacity:	gal	105
Noise level	dB	65



KST selection guide

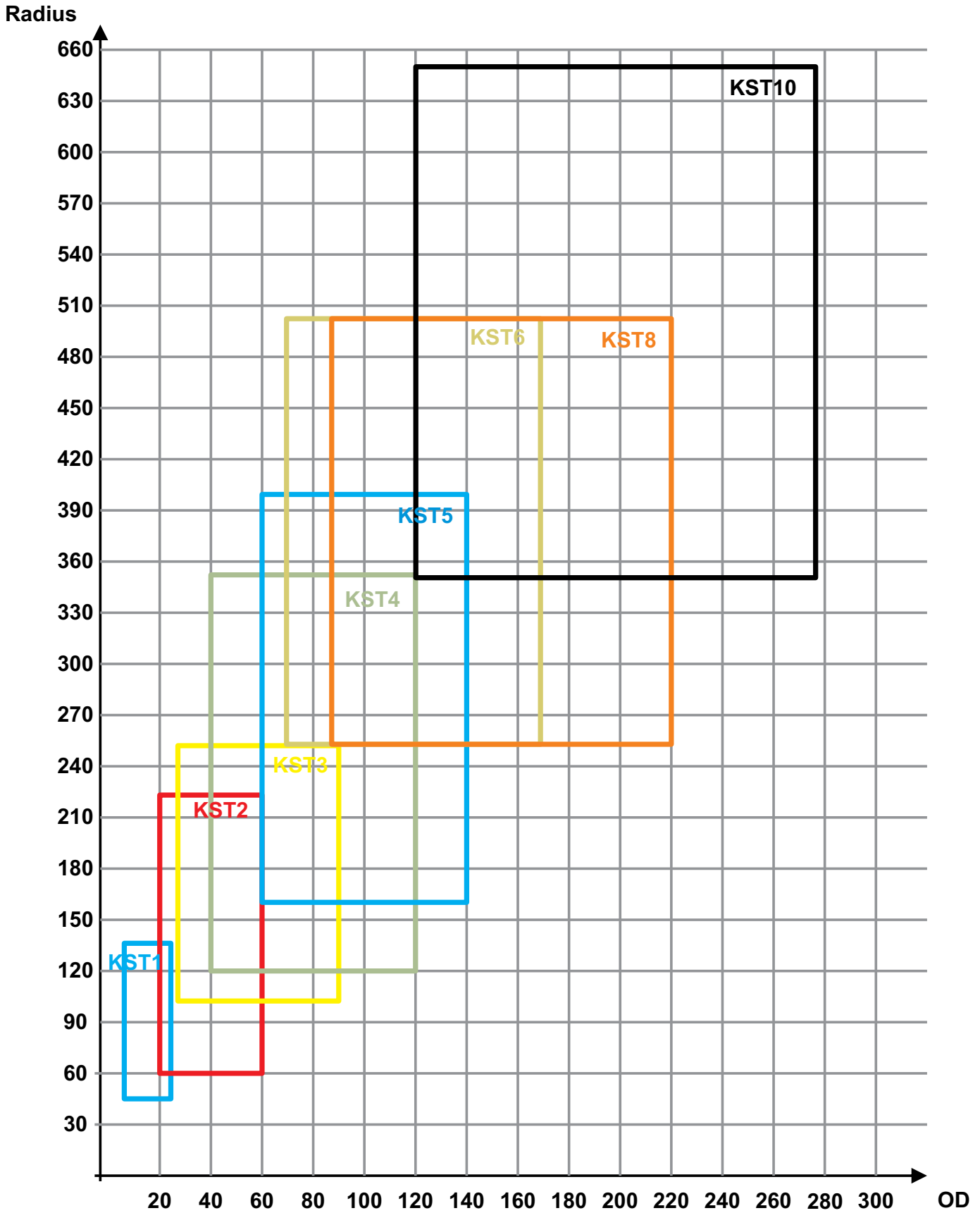

Giga Bender Features for Bending Heavy Tube and Profiles

Bend Head

New patented bending head concept travels horizontally to adjust for bending radius. GB series bending head is manufactured from GS 500 spheroidal cast iron to absorb vibrations during the bend cycle providing maximum stability with high torque.

Clamp System

Clamp integrates to the top of bend die allowing more space to position the tube while providing optimal clamp pressure. Safely eliminates swing arm movement, reduces flexing and minimizes tooling setup and change over.

Booster Function

Booster function pushes the tube into bending die to minimize tube thinning in the extrados and prevent movement in clamp. Booster with adjustable speed features recapture function for deep angles ensuring the booster pressure throughout the bend length. Boost position monitored with digital encoder and is adjustable through programming eliminated manual adjustments.

Tailstock Carriage

Tailstock features large pass enabling control to program recapture of longer tube as necessary for the customer application. Segmented collets clamp securely with dual hydraulic cylinders. Y-axis with radial slide moves during the bend cycle accommodating radial growth and reduces pressure on linear axis.

Machine Structure

Ercolina GB series have a patented machine frame system working in flexion providing increased stability and accuracy with reduced weight. The tube axis positioned inside machine structure unlike conventional bending machines, which use weight to compensate for design.

Mandrel Retract System

Mandrel position is controlled with encoder and adjustable with software, eliminating manual positioning. Program features anticipated mandrel retraction and positioning for better bend quality. Mandrel rod installed or removed with easy release locking pin for faster tooling change. Mandrel rod can be stationary or can rotate as required.



Giga Bender Tooling Line

Tooling line E - Finger Style

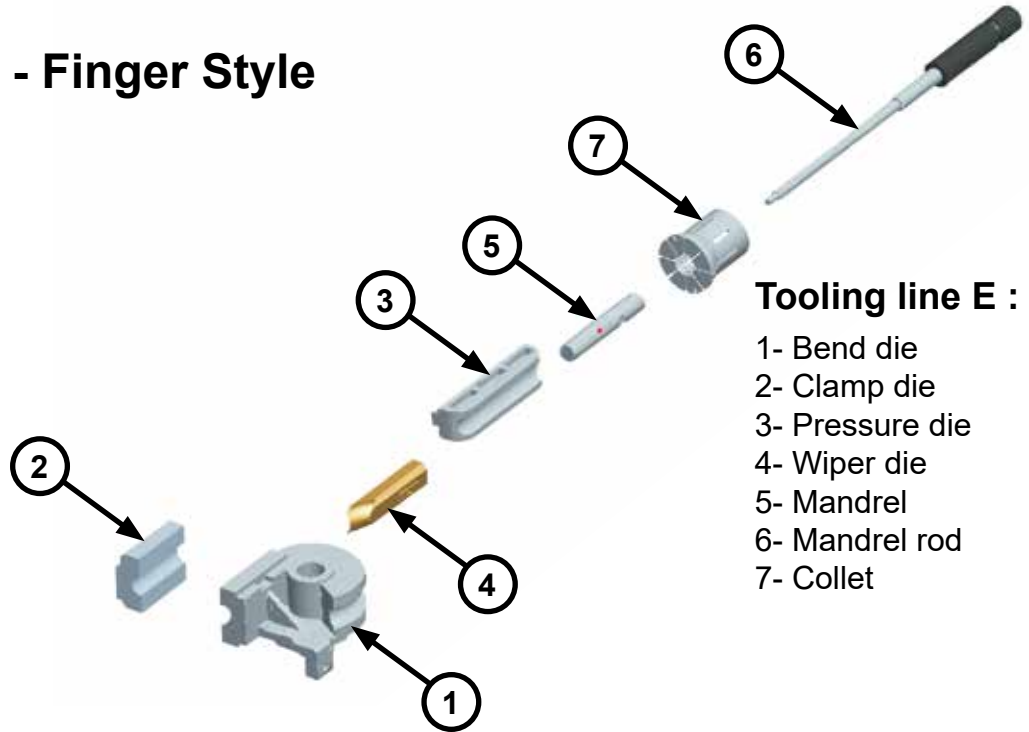

Tooling line E :

- 1- Bend die
- 2- Clamp die
- 3- Pressure die
- 4- Wiper die
- 5- Mandrel
- 6- Mandrel rod
- 7- Collet

Tooling line G - KST Style

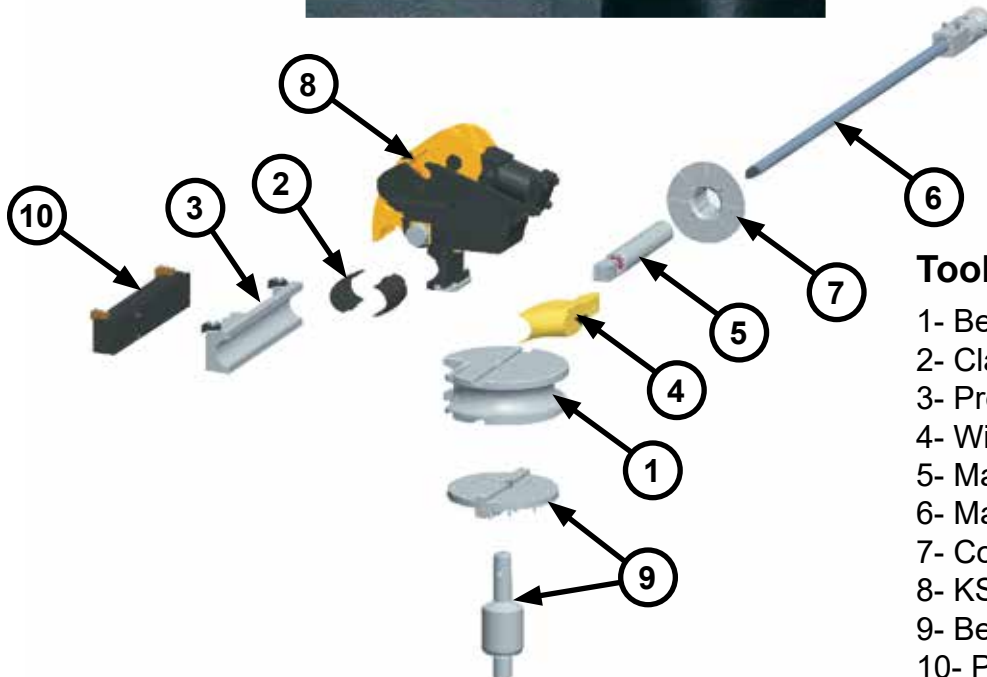

Tooling line G :

- 1- Bend die
- 2- Clamp die
- 3- Pressure die
- 4- Wiper die
- 5- Mandrel
- 6- Mandrel rod
- 7- Collet
- 8- KST clamping kit
- 9- Bend die interface
- 10- Pressure die interface

Giga Bender KST Clamping Kit

KST Clamping Kit Technical Data



KST Part #	Height	Max OD	Min OD	Max Ra	Min Ra
KST1	2.07	1.0	0.5	4.5	1.2
KST2	3.9	2.3	0.7	5.5	3.9
KST3	5.5	3.5	0.9	9.8	5.5
KST4	6.6	4.7	1.5	13.7	7.0
KST5	7.8	5.5	2.3	15.7	7.8
KST6	8.6	6.6	2.7	19.6	11.8

Machine	KST1	KST2	KST3	KST4	KST5	KST6
GB100	X	X	X	X		
GB130	X	X	X	X	X	
GB200	X	X	X	X	X	X



**EB65 & EB76
MOUNTING TOOLING**



**030 MANDREL
MAKING A MANDREL BEND**



**ERCO BENDER 65
BENDING STEEL**



**ERCO BENDER 76
BENDING COPPER**



**ERCO BENDER 65
BENDING HANDRAIL**



ANGLE ROLLS SECTION BENDERS



Angle Rolls - Section Benders Table of Contents

• Why choose Ercolina Angle Rolls?.....	74-75
• CE40MR3 Angle Roll.....	76-77
• CE40H3 Angle Roll.....	78-79
• CE50H3 Angle Roll.....	80-81
• CE60H3 Angle Roll.....	82-83
• CE70H3-RLI Angle Roll.....	84-85
• CE100H3-RLI Angle Roll.....	86-87
• Minimum radius guide	88-89
• Universal tooling sets	90
• Modular tooling sets	90
• Angle roll-section bender pipe tooling sets.....	91
• Angle roll-section bender tube tooling sets.....	91
• Polymer roll tooling sets	92
• Small radius tooling	92
• Cap rail & profile tooling	92
• Angle roll-section bender accessories.....	93-94
• Bar twisting device	95
• Scroll curling device	96



ANGLE ROLLS - SECTION BENDERS





Why choose Ercolina Angle Rolls?

Ercolina Advantages

All Ercolina hydraulic machines have **unlimited** step programming with memory and unlimited passes which is important when rolling parts

Ercolina rolls feature patented simultaneous downfeed and roll movement to minimize part deformation when making roll passes

Ercolina shafts and tooling are forged
(Forging generally produces a piece that is stronger than a similar cast or machined part. During the forging process, the metal's internal grain deforms to follow the general shape of the part. The resulting grain is continuous throughout the part creating a piece with improved strength characteristics and reliability.)

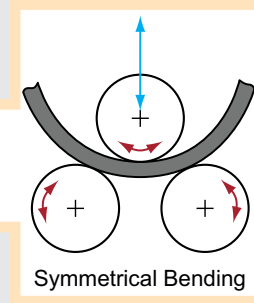

Ercolina A-frames are engineered for greater strength

Ercolina utilizes heavy lateral guides to control material during bending

Ercolina rolls are three-roll-driven with inline gear reduction for greater torque; power transmission and motor are located close to the A-frame

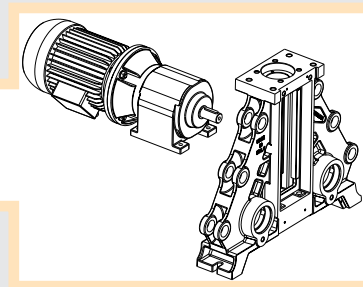

Ercolina hydraulic rolls have locking third hydraulic solenoid to maintain accurate cylinder position

Ercolina capacity ratings are accurate and machines will perform as advertised with standard tooling

Ercolina hydraulic cylinder is located inside the cabinet and cannot interfere with part production

Ercolina rolls include a slip clutch on drive to protect machine components when rolling



Ercolina design and tooling accommodate most standard material



CE40MR3 (Manual)
CE40H3 (Hydraulic)
2" Sch. 40 pipe capacity
2" angle iron capacity
220V or 440V 3ph



CE50H3 (Hydraulic)
2-1/2" Sch. 40 pipe capacity
2-1/2" angle iron capacity
220V or 440V 3ph



CE60H3 (Hydraulic)
3" Sch. 10 pipe capacity
2-1/2" angle iron capacity
220V or 480V 3ph

Ercolina offers a better machine at a competitive price.

Competitors' Machines

Competitive brand machines require operator to manually control step movement which is inefficient and less accurate

On competitive brand machines, downward movement of center roll causes deformation when taking roll passes



Competitive brand shafts and tooling are turned and hardened which are more likely to flex during bending

Competitive brand A-frames use welded steel plate or billet allowing weight to compensate for older design

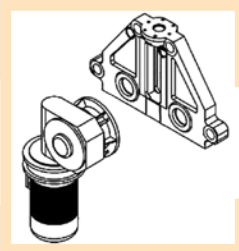

Competitive brands have weaker lateral guides do not offer required support

Competitive brand motors are further away and the drive train is at 90 degrees which requires a larger motor to overcome the transition

Competitive brands rely on single solenoid

Competitive brands often over-state capacity ratings

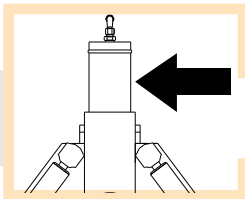

On competitive brands, the hydraulic cylinder located at top of machine can interfere with part production

If vibration occurs during bending process, some competitors suggest removing the key drive from the lower right shaft to make the rolls freewheeling

Competitive brands' stated capacities often require special tooling



CE70H3 (Hydraulic)
3" Sch. 40 pipe capacity
3" angle iron capacity
220V or 440V 3ph



CE100H3-RLI (Hydraulic)
4" Sch. 40 pipe capacity
4" angle iron capacity
220V or 440V 3ph





CE40MR3 Angle Roll

Manual Angle Roll • Section Bender



Vertical or Horizontal Operating Position



Universal Tooling Set Included for Multiple Profiles



Two-Speed Gear Box

- 1 - Torque or fine adjustment
- 2 - Rapid or coarse adjustment

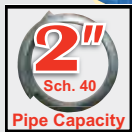

Manual Center Roll Positioning

FEATURES

- Universal tooling set forged with smooth surface included with each machine
- Forged roll shafts precision ground and fitted for maximum performance and minimal deflection
- Roll shafts supported with conical steel bearings on each side of A Frame
- Heavy duty structure and rigid components for high section modulus ratings
- Reinforced engineered mainframe design proven to outperform competitive models
- In-line direct drive roll shaft system 3-roll driven
- Threaded roll shafts with micrometric flange adjustment helps eliminate spacer usage
- Touchpad control with digital readout of center roll positioning
- Control tower with low voltage controls and foot pedal
- 2-speed gear box with torque multiplier for positioning center roll
- Optional anti-twist correction system required for angle iron "Leg In" applications

CE40MR3 Capacities & Specifications

9/8.1

Pipe (Max.)	2" Sch. 40
Angle (Max.)	2" x 2" x 1/4"
Tube (Max.)	2 1/2" - .125 wall
Roll Shaft Diameter	40mm
Center Roll Positioning	Manual with patented torque multiplier
Shaft Speed	10 RPM
Universal Tooling (Included)	6 5/8" O.D.
Programming	Not available
Distance between Shafts	10 5/8"
Operating Voltage	220V or 480V 3ph
Length, Width, Height	39" x 26" x 59"
Weight	775 lbs.

All capacities based on mild grade materials; heavy wall and high tensile materials reduce machine capacity.

POPULAR ACCESSORIES



Spray Lubricant



Pipe & Tube Tooling



Anti-Twist Device



Small Radius Tooling



Radius & Degree Measuring Kit

Minimum Radius Guide [Pages 88-89](#)

Tooling Sets [Pages 90-92](#)

Accessories [Pages 93-96](#)



◀ Ercolina Bending Application

Product Demonstrations Available on Website

NEED ADDITIONAL HELP? CONTACT ERCOLINA:

563.391.7700

info@ercolina-usa.com



CE40H3 Angle Roll

Hydraulic Angle Roll • Section Bender

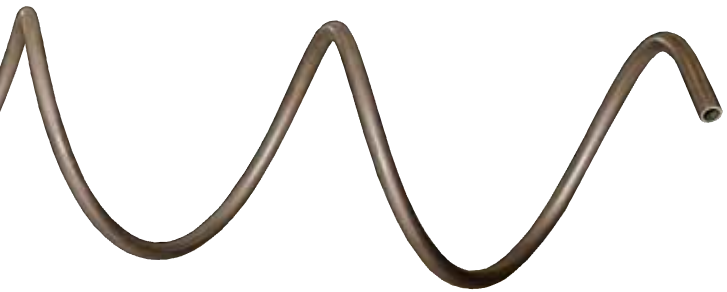

Universal Tooling Set Included for Multiple Profiles



Vertical or Horizontal
Operating Position



Hydraulic Center Roll Positioning

FEATURES

- Universal tooling set included with each machine
- Forged roll shafts precision ground and fitted for maximum performance and minimal deflection
- Roll shafts supported with conical steel bearings on each side of A Frame
- Heavy duty structure and rigid components for high section modulus ratings
- Reinforced engineered mainframe design proven to outperform competitive models
- In-line direct drive roll shaft system 3-roll driven
- Threaded roll shafts with micrometric flange adjustment helps eliminate spacer usage
- Touchpad controls with digital center roll positioning
- Control tower with low voltage controls and foot pedal
- Machine with memory storage has eight (8) individual programs and unlimited passes
- Patented by Ercolina, simultaneous downfeed and roll movement minimizes deformation
- Optional anti-twist correction system required for angle iron "Leg In" applications

CE40H3 Capacities & Specifications

9/8.1

Pipe (Max.)	2" Sch. 40
Angle (Max.)	2" x 2" x 1/4"
Tube (Max.)	2 1/2" - .125 wall
Roll Shaft Diameter	40mm
Center Roll Positioning	Hydraulic 10 Tons
Shaft Speed	10 RPM
Universal Tooling (Included)	6 5/8" O.D.
Programming	NC - Touchpad
Distance between Shafts	10 5/8"
Operating Voltage	220V or 480V 3ph
Length, Width, Height	39" x 26" x 59"
Weight	865 lbs.

All capacities based on mild grade materials;
heavy wall and high tensile materials reduce machine capacity.

POPULAR ACCESSORIES



Spray Lubricant



Pipe & Tube Tooling



Anti-Twist Device



Small Radius Tooling



Radius & Degree Measuring Kit

Minimum Radius
Guide [Pages 88-89](#)

Tooling Sets [Pages 90-92](#)

Accessories [Pages 93-96](#)



◀ Ercolina Bending Application

**Product
Demonstrations
Available on Website**

**NEED ADDITIONAL HELP?
CONTACT ERCOLINA:**

563.391.7700

info@ercolina-usa.com



CE50H3 Angle Roll

Hydraulic Angle Roll • Section Bender



Vertical or Horizontal Operating Position



Universal Tooling Set Included for Multiple Profiles



Shown with optional Large Radius Spiral Bending Accessory

2 1/2"
Sch. 40
Pipe Capacity

1 Year
Limited
WARRANTY

Hydraulic Downfeed Improves Productivity

FEATURES

- Universal tooling set included with each machine
- Forged roll shafts precision ground and fitted for maximum performance and minimal deflection
- Roll shafts supported with conical steel bearings on each side of A Frame
- Heavy duty structure and rigid components for high section modulus ratings
- Reinforced engineered mainframe design proven to outperform competitive models
- In-line direct drive roll shaft system 3-roll driven
- Threaded roll shafts with micrometric flange adjustment helps eliminate spacer usage
- Touchpad controls with digital center roll positioning
- Control tower with low voltage controls and foot pedal
- Hydraulic machine with memory storage has eight (8) individual programs and unlimited passes
- Patented by Ercolina, simultaneous downfeed and roll movement minimizes deformation
- Optional anti-twist correction system required for angle iron "Leg In" applications

CE50H3 Capacities & Specifications

16/9

Pipe (Max.)	2½" Sch. 40
Angle (Max.)	2½" x 2½" x ¼"
Tube (Max.)	3" – .095 wall
Roll Shaft Diameter	50mm
Center Roll Positioning	Hydraulic 10 Tons
Shaft Speed	9 RPM
Universal Tooling (Included)	7" O.D.
Programming	NC - Touchpad
Number of Programs	8
Distance between Shafts	11⅞"
Operating Voltage	220V or 480V 3ph
Length, Width, Height	45" x 29" x 52"
Weight	1310 lbs.

All capacities based on mild grade materials; heavy wall and high tensile materials reduce machine capacity.

POPULAR ACCESSORIES



Spray Lubricant



Pipe & Tube Tooling



Anti-Twist Device



Small Radius Tooling



Radius & Degree Measuring Kit

Minimum Radius
Guide [Pages 88-89](#)

Tooling Sets [Pages 90-92](#)

Accessories [Pages 93-96](#)



◀ Ercolina Bending Application

**Product
Demonstrations
Available on Website**

**NEED ADDITIONAL HELP?
CONTACT ERCOLINA:**

563.391.7700

info@ercolina-usa.com



CE60H3 Angle Roll

Hydraulic Angle Roll • Section Bender



Universal Tooling Set Included for Multiple Profiles



Vertical or Horizontal Operating Position

Hydraulic Downfeed Improves Productivity

FEATURES

- Universal tooling set included with each machine
- Forged roll shafts precision ground and fitted for maximum performance and minimal deflection
- Roll shafts supported with conical steel bearings on each side of A Frame
- Heavy duty structure and rigid components for high section modulus ratings
- Reinforced engineered mainframe design proven to outperform competitive models
- In-line direct drive roll shaft system 3-roll driven
- Uses CE50 tooling
- Threaded roll shafts with micrometric flange adjustment helps eliminate spacer usage
- Touchpad controls with digital center roll positioning
- Control tower with low voltage controls and foot pedal
- Hydraulic machine with memory storage has eight (8) individual programs and unlimited passes
- Patented by Ercolina, simultaneous downfeed and roll movement minimizes deformation
- Optional anti-twist correction system required for angle iron "Leg In" applications
- Tie bar supports for each shaft included

CE60H3 Capacities & Specifications

23.5/16

Pipe (Max.)	3" Sch. 10
Angle (Max.)	2½" x 2½" x ⅜"
Tube (Max.)	3½" – .120 wall
Roll Shaft Diameter	50mm
Center Roll Positioning	Hydraulic 17.6 Tons
Shaft Speed	9 RPM
Universal Tooling (Included)	7" O.D.
Programming	NC - Touchpad
Number of Programs	8
Distance between Shafts	15"
Operating Voltage	220V or 480V 3ph
Length, Width, Height	48" x 29" x 52"
Weight	1480 lbs.

All capacities based on mild grade materials; heavy wall and high tensile materials reduce machine capacity.

POPULAR ACCESSORIES



Spray Lubricant



Pipe & Tube Tooling



Anti-Twist Device



Large Spiral Accessory



Radius & Degree Measuring Kit

Minimum Radius
Guide [Pages 88-89](#)

Tooling Sets [Pages 90-92](#)

Accessories [Pages 93-96](#)



◀ Ercolina Bending Application

**Product
Demonstrations
Available on Website**

**NEED ADDITIONAL HELP?
CONTACT ERCOLINA:**

563.391.7700

info@ercolina-usa.com



CE70H3-RLI Angle Roll

Hydraulic Angle Roll • Section Bender



Universal Tooling Set Included for Multiple Profiles

CE70H3-RLI w/Hydraulic 3 Axis Twist



Vertical or Horizontal
Operating Position



Heavy Duty Structure for High Section Modulus Rating

FEATURES

- Universal tooling set included with each machine
- Forged roll shafts precision ground and fitted for maximum performance and minimal deflection
- Roll shafts supported with conical steel bearings on each side of A Frame
- Heavy duty structure and rigid components for high section modulus ratings
- Reinforced engineered mainframe design proven to outperform competitive models
- In-line direct drive roll shaft system with motor and brake on each shaft
- Threaded roll shafts with micrometric flange adjustment helps eliminate spacer usage
- Touchpad controls with digital center roll positioning
- Control tower with low voltage controls and foot pedal
- Memory storage has eight (8) individual programs and unlimited passes
- Three axis hydraulic twist correction system for angle iron "Leg-in" applications

CE70H3-RLI Capacities & Specifications

35/50

Pipe (Max.)	3" Sch. 40
Angle (Max.)	3" x 3" x 3/8"
Tube (Max.)	3 1/2" - .216 wall
Roll Shaft Diameter	70mm
Center Roll Positioning	Hydraulic 22 Tons
Shaft Speed	8 RPM
Universal Tooling (Included)	9 1/2" O.D.
Programming	NC - Touchpad
Number of Programs	8
Distance between Shafts	15"
Section Modulus	35 cm ³
Operating Voltage	220V or 480V 3ph
Length, Width, Height	54" x 43" x 57"
Weight	3300 lbs.

All capacities based on mild grade materials; heavy wall and high tensile materials reduce machine capacity.

POPULAR ACCESSORIES



Spray Lubricant



Pipe & Tube Tooling



Modular Tooling Set



Large Spiral Accessory



Radius & Degree Measuring Kit

Minimum Radius
Guide [Pages 88-89](#)

Tooling Sets [Pages 90-92](#)

Accessories [Pages 93-96](#)



◀ Ercolina Bending Application

**Product
Demonstrations
Available on Website**

**NEED ADDITIONAL HELP?
CONTACT ERCOLINA:**

563.391.7700

info@ercolina-usa.com



CE100H3-RLI Angle Roll

Hydraulic Angle Roll • Section Bender



Universal Tooling Set Included for Multiple Profiles



Vertical or Horizontal Operating Position



Maximum Performance and Minimal Deflection

FEATURES

- Universal tooling set included with each machine
- Forged roll shafts precision ground and fitted for maximum performance and minimal deflection
- Roll shafts supported with conical steel bearings on each side of A Frame
- Heavy duty structure and rigid components for high section modulus ratings
- Reinforced engineered mainframe design proven to outperform competitive models
- In-line direct drive roll shaft system with motor and brake on each shaft
- Threaded roll shafts with micrometric flange adjustment helps eliminate spacer usage
- Touchpad controls with digital center roll positioning
- Control tower with low voltage controls and foot pedal
- Memory storage has eight (8) individual programs and unlimited passes
- Three axis hydraulic twist correction system for angle iron "Leg-in" applications

CE100H3-RLI Capacities & Specifications

90/50

Pipe (Max.)	4" Sch. 40
Angle (Max.)	4" x 4" x 1/2"
Tube (Max.)	4 1/2" - .237 wall
Roll Shaft Diameter	100mm
Center Roll Positioning	Hydraulic 30 Tons
Shaft Speed	6 RPM
Universal Tooling (Included)	12 5/8" O.D.
Programming	NC - Touchpad
Number of Programs	8
Distance between Shafts	19 1/4"
Section Modulus	90 cm ³
Operating Voltage	220V or 480V 3ph
Length, Width, Height	66" x 58" x 83"
Weight	5940 lbs

All capacities based on mild grade materials;
heavy wall and high tensile materials reduce machine capacity.

POPULAR ACCESSORIES



Spray Lubricant



Pipe & Tube Tooling



Modular Tooling Set



Polymer Tooling



Radius & Degree Measuring Kit

Minimum Radius
Guide [Pages 88-89](#)

Tooling Sets [Pages 90-92](#)

Accessories [Pages 93-96](#)



◀ Ercolina Bending Application

**Product
Demonstrations
Available on Website**

**NEED ADDITIONAL HELP?
CONTACT ERCOLINA:**

563.391.7700

info@ercolina-usa.com



Minimum Radius Guide on Mild Steel Material

Profile Type	CE40			CE50		
	Profile Dimensions	Min. CLR Inches	Wall	Profile Dimensions	Min. CLR Inches	Wall
Pipe	½"	6	.109	¾"	8	.113
	1"	10	.133	2"	18	.154
	2"	18	.154	2½"	32	.203
Tube	1"	6	.120	1"	8	.120
	1½"	12	.120	2½"	18	.120
	2½"	26	.083	3"	24	.120
Square Tube	¾" x ¾"	6	.083	¾" x ¾"	6	.083
	1½" x 1½"	16	.083	2" x 2"	24	.120
	2" x 2"	24	.120	2½" x 2½"	30	.120
Rectangular Tube Hard way	½" x 1¼"	10	.083	½" x 1"	8	.083
	1" x 1½"	12	.120	1½" x 2½"	18	.120
	1" x 2"	24	.120	1½" x 3"	34	.120
Rectangular Tube Easy way	1¼" x ½"	10	.083	1¼" x ½"	10	.083
	2" x 1"	20	.120	2½" x 1½"	24	.120
				3" x 1½"	32	.120
Round Solid	¾"	4 *	NA	¾"	4 *	NA
	1¼"	12	NA	1½"	14	NA
Square Solid	¾"	4 *	NA	¾"	4 *	NA
	1"	8	NA	1¼"	10	NA
	1¼"	10	NA	1½"	6	NA
Rectangular Solid Hard way	½" x 1½"	12	NA	⅜" x ¾"	6 *	NA
	¼" x 2"	16	NA	½" x 2"	10	NA
	½" x 2"	18	NA	½" x 2½"	18	NA
Rectangular Solid Easy way	1¼" x ⅜"	6 *	NA	2" x ½"	8	NA
	2½" x ½"	8	NA	4" x ½"	12	NA
	3" x ½"	16	NA			
Angle "Leg Out"	1" x 1"	8	.120	1" x 1"	8	.120
	1½" x 1½"	12	.120	2" x 2"	16	.187
	2" x 2"	16	.187	2½" x 2½"	20	.187
Angle "Leg In"	1" x 1"	10	.120	1" x 1"	12	.120
	1½" x 1½"	16	.120	2" x 2"	28	.236
	2" x 2"	28	.187	2½" x 2½"	32	.236
C "Leg Out"	1½" x ½"	10	.120	1¼" x ½"	10	.120
	2" x 1¼"	14	.187	3" x 1½"	16	.187
C "Leg In"	1½" x ¾"	10	.187	1½" x ¾"	10	.187
	2½" x 1¼"	14	.187	3" x 1½"	16	.187

1. Capacities based on mild grade material, number of bending passes may vary.
2. Tie Bar accessory required for bending large profiles.
3. Two roll drive machines increase minimum CLR.

Minimum Radius Guide on Mild Steel Material

CE60			CE70			CE100		
Profile Dimensions	Min. CLR Inches	Wall	Profile Dimensions	Min. CLR Inches	Wall	Profile Dimensions	Min. CLR Inches	Wall
3/4"	8	.113	1 1/2"	16	.145	2"	22	.154
2"	20	.154	3"	32	.216	4"	36	.237
3"	30	.120						
1"	8	.120	1 1/2"	16	.120	2"	20	.120
2 1/2"	28	.203	4"	30	.187	4"	32	.187
3 1/2"	30	.187				6"	76	.187
3/4" x 3/4"	6	.083	1 1/2" x 1 1/2"	12	.120	2" x 2"	14	.120
2" x 2"	20	.120	3" x 3"	48	.187	4" x 4"	72	.187
2 1/2" x 2 1/2"	30	.216						
1/2" x 1"	6	.083	1/2" x 1 1/2"	10	.120	1" x 2 1/2"	16	.187
1 1/2" x 2 1/2"	18	.120	2" x 4"	48	.187	2" x 4"	48	.187
1 1/2" x 4"	36	.187						
1 1/4" x 1/2"	6	.083	1 1/2" x 1/2"	10	.120	2 1/2" x 1"	14	.187
2 1/2" x 1 1/2"	24	.120	4" x 2"	72	.187	4" x 2"	72	.187
4" x 1 1/2"	60	.187						
1"	8 *	NA	1 1/4"	6 *	NA	1 1/2"	8 *	NA
1 3/4"	16	NA	2"	16	NA	2 1/2"	24	NA
3/4"	4 *	NA	1 1/2"	10 *	NA	1 1/2"	14	NA
1 1/4"	10	NA	2"	16	NA	2"	18	NA
1 3/4"	20	NA						
3/8" x 3/4"	6 *	NA	1/2" x 1 1/2"	14	NA	1/2" x 1 1/2"	16	NA
1/2" x 2"	8	NA	1/2" x 3"	32	NA	3/4" x 4"	42	NA
3/4" x 3"	40	NA						
2" x 1/2"	8	NA	1 1/2" x 1/2"	12	NA	2" x 1/2"	14	NA
4" x 3/4"	16	NA	4" x 1"	16	NA	6" x 1"	32	NA
1" x 1"	12	.156	1 1/2" x 1 1/2"	14	.187	2" x 2"	16	.187
2" x 2"	20	.236	3" x 3"	28	.375	3" x 3"	28	.375
2 1/2" x 2 1/2"	26	.236				4" x 4"	36	.500
1" x 1"	14	.156	1 1/2" x 1 1/2"	16	.187	2" x 2"	20	.187
2" x 2"	28	.236	3" x 3"	32	.375	3" x 3"	32	.375
2 1/2" x 2 1/2"	36	.236				4" x 4"	40	.500
1 1/2" x 3/4"	10	.156	2" x 1"	14	.187	2" x 1"	14	.187
3 3/8" x 1"	18	.236	4" x 1 1/2"	24	.187	6" x 2"	60	.375
1 1/2" x 3/4"	10	.203	2" x 1"	14	.125	2" x 1"	14	.187
4" x 1 1/2"	18	.236	4" x 1 1/2"	24	.187	6" x 2"	60	.375

*Special tooling required

Consult CML USA, Inc. Ercolina® with application questions.

Consult factory for material and radii not shown.



Universal Tooling Sets

All Ercolina angle roll-section bending machines **include** universal tooling sets. Universal tooling adjusts easily to bend the following profiles:

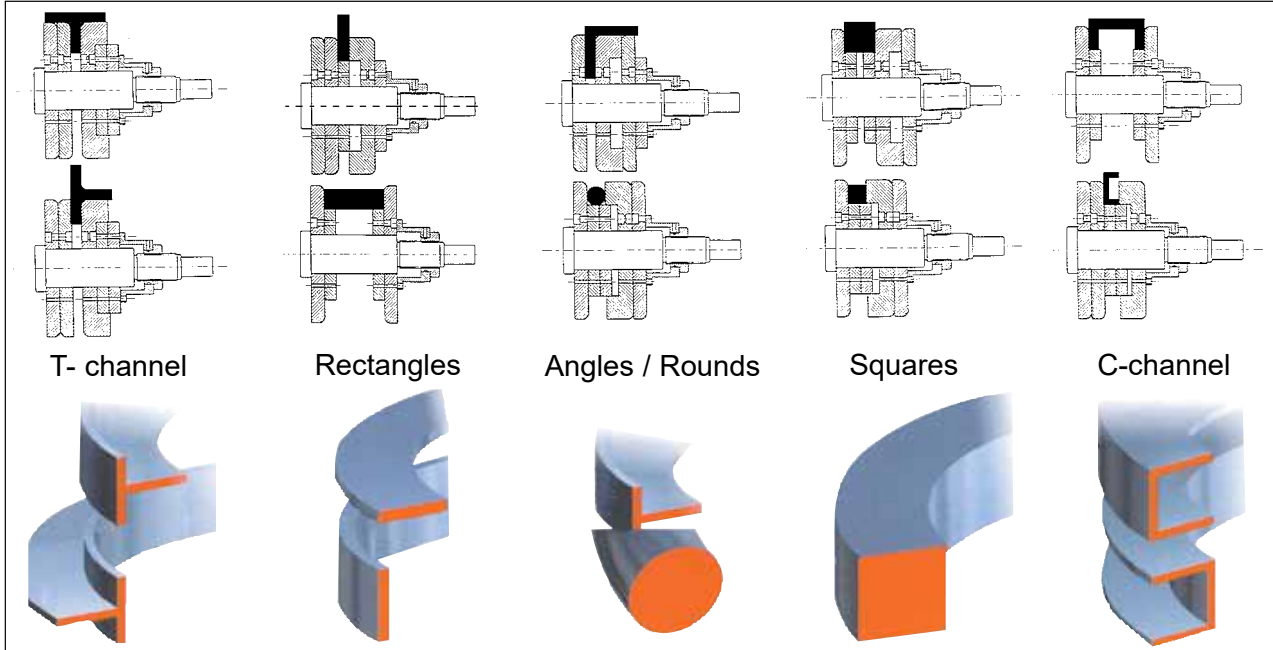

Part#	Description
C4ST	CE40 – Universal tooling set
C5ST	CE50 - CE60 – Universal tooling set
C7ST	CE70 – Universal tooling set
C100ST	CE100 – Universal tooling set



Universal tooling set in Polymer available:
CE40 (C4STPOLY)
and CE50 - CE60 (C5STPOLY)

Modular Tooling Sets

Modular tooling sets support profiles, maintain smooth radius edges and reduce sharp knife-like edges.



Part#	Description
C4RC	CE40 – 6 flanges and 6 spacers
C4RCPOLY	CE40 – Poly modular tooling set
C5RC	CE50 - CE60 – 6 flanges and 9 spacers
C5RCPOLY	CE50 - CE60 – Poly modular tooling set
C70RC	CE70 – 6 flanges and 15 spacers
C100RC	CE100 – 6 flanges and 12 spacers

Angle Roll-Section Bender Pipe Tooling Sets



Size	O.D.	CE40	CE50 - CE60	CE70	CE100
1/4"	.540	C401P0250	C501P0250	NA	NA
3/8"	.675	C401P0375	C501P0375	*	*
1/2"	.840	C4SPD2**	C5SPD2**	*	*
3/4"	1.050	C4SPD1**	C5SPD1**	*	*
1"	1.315	C4SPD1**	C5SPD1**	C70P1000	C100P1000
1 1/4"	1.660	C4SPD2**	C5SPD2**	C70P1250	C100P1250
1 1/2"	1.900	C401P1500	C501P1500	C70P1500	C100P1500
2"	2.375	C401P2000	C501P2000	C70P2000	C100P2000
2 1/2"	2.875	NA	C501P2500	C70P2500	C100P2500
3"	3.500	NA	C501P3000†	C70P3000	C100P3000
4"	4.500	NA	NA	NA	C100P4000

* Special order - consult factory for delivery

** Combination Twin Tool Sets

† Only available for CE60 model

Consult factory for tooling sizes not shown.

Angle Roll-Section Bender Tube Tooling Sets

Size	O.D.	CE40	CE50 - CE60	CE70	CE100
1/4"	.250	C401T0250	C501T0250	NA	NA
3/8"	.375	C401T0375	C501T0375	NA	NA
1/2"	.500	C401T0500	C501T0500	NA	NA
5/8"	.625	C401T0625	C501T0625	NA	NA
3/4"	.750	C401T0750	C501T0750	NA	NA
7/8"	.875	C401T0875	C501T0875	NA	NA
1"	1.000	C401T1000	C501T1000	NS*	NS*
1 1/8"	1.125	C401T1125	C501T1125	NS*	NS*
1 1/4"	1.250	C401T1250	C501T1250	NS*	NS*
1 3/8"	1.375	C401T1375	C501T1375	NS*	NS*
1 1/2"	1.500	C401T1500	C501T1500	NS*	NS*
1 5/8"	1.625	C401T1625	C501T1625	NS*	NS*
1 3/4"	1.750	C401T1750	C501T1750	NS*	NS*
1 7/8"	1.875	C401T1875	C501T1875	NS*	NS*
2"	2.000	C401T2000	C501T2000	C70T2000	C100T2000
2 1/8"	2.125	C401T2125	C501T2125	NS*	NS*
2 1/4"	2.250	C401T2250	C501T2250	NS*	NS*
2 1/2"	2.500	C401T2500	C501T2500	C70T2500	C100T2500
2 3/4"	2.750	NA	C501T2750	NS*	NS*
3"	3.000	NA	C501T3000	C70T3000	C100T3000
4"	4.000	NA	NA	NA	C100T4000

* Not stocked. Special order - consult factory for delivery.



Polymer Roll Tooling Sets



Polymer tooling maintains material appearance reducing scratching and blemishes.



Polymer Pipe Tooling

Size	O.D.	CE40	CE50 - CE60
1"	1.315	C401NP1000	C501NP1000
1¼"	1.660	C401NP1250	C501NP1250
1½"	1.900	C401NP1500	C501NP1500
2"	2.375	C401NP2000	C501NP2000
2½"	2.875	NA	C501NP2500

Polymer Tube Tooling

Size	O.D.	CE40	CE50 - CE60
1"	1.000	C401NT1000	C501NT1000
1¼"	1.250	C401NT1250	C501NT1250
1½"	1.500	C401NT1500	C501NT1500
1¾"	1.750	C401NT1750	C501NT1750
2"	2.000	C401NT2000	C501NT2000
2½"	2.500	C401NT2500	C501NT2500

Small Radius Tooling

Small Radius Tooling

Adjustable tooling set for small radius bending applications.

Tooling Material Capacities

Profile	Maximum
Square solids	5/8" x 5/8"
Rectangular solids	3/4" x 1/4"
Rounds	5/8"
T Stock	3/4" x 3/4"

Part# C4RR fits CE40
Part# C5RR fits CE50



Cap Rail & Profile Tooling

Available by special order for angle roll machines.
Consult CML USA with specific profile and dimensions.

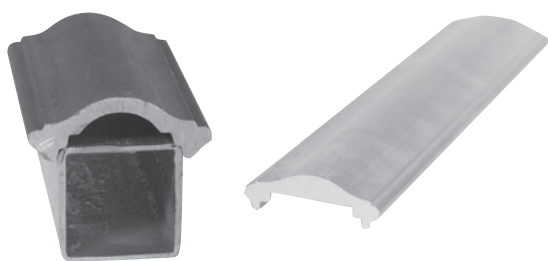

Angle Roll-Section Bender Accessories

Large Spiral Bending Accessory

Ideal for large pitch spiral bending applications. Material capacity 2" outside diameter.

Part# **CS5A11** fits CE40 - CE50 - CE60

Part# **CS7A11** fits CE70

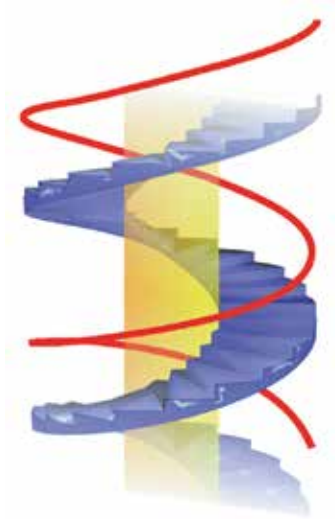
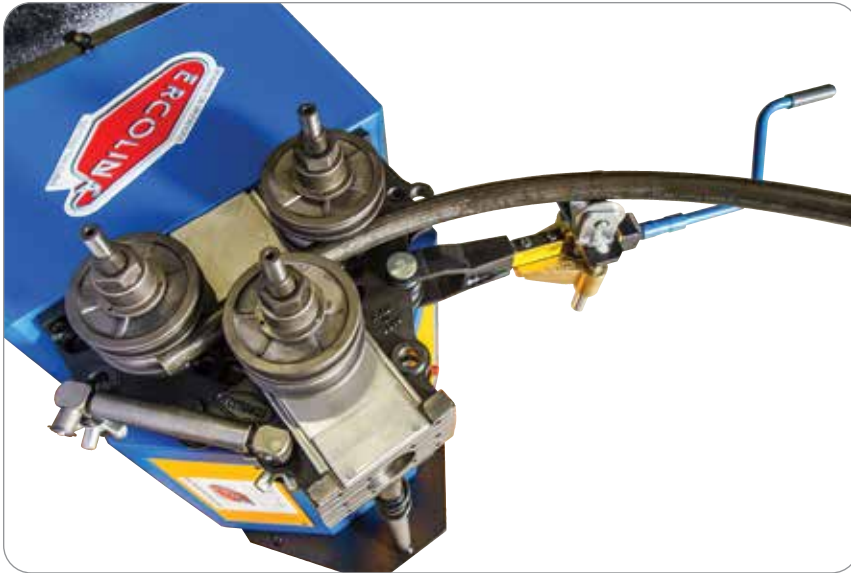



Angle Roll-Section Bender Accessories



Tie Bar Accessory

Recommended when bending large profiles or heavy wall material. Increases roll shaft rigidity and radii accuracy.

Part# **C5A2** fits CE40 and CE50

Part# **CE70A2** fits CE70

Part# **CE100A2** fits CE100



Anti-Twist Device

Required for Angle iron "Leg In" applications.

Part# **C5A4** fits CE40 - CE50 - CE60

Circular Segment

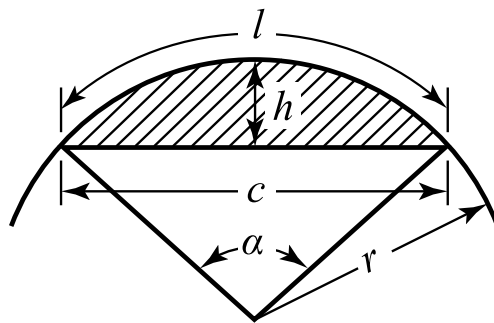

$$r = \frac{c^2 + 4h^2}{8h}$$

l = length of arc; h = height at midpoint of chord; c = chord length;
 α = angle, in degrees; r = radius.



Fabricator's Measuring Set

Radius & Degree Measuring Kit - Part# **KARC**

Part#	Description of Kit Contents
ARC160	Chord Gauge 160 mm
ARC350	Chord Gauge 350 mm
FWOC001	Digital Radius Gauge
FXC025	Digital Angle Degree Protractor

Bar Twisting Device

Part# **CT4/2300** fits CE40

Part# **CT5/2300** fits CE50



Tooling included for Bar Twisting and Bending Small Spiral Tight Radius Rings and Hoops



- Quickly adapts to CE40 and CE50 angle rolls to create custom components for ornamental gates, railing and more
- Twists balusters up to 1" square
- Heavy duty construction with over (7') of workable table length
- Electromechanical interface provided to control rotation and repeatability
- Self aligning chuck and quick release tailstock system for easy material changeover







Ornamental Metalworking Accessories

Scroll Curling Device

Part# **CR4A8** fits CE40
 Part# **CR5A8** fits CE50 and CE60



- Quickly adapts to CE40, CE50 and CE60 ring rolls to produce ornamental scrollwork
- Electromechanical interface provided to control exact rotation and repeatability
- Patented scroll pattern chain with removable links allows operator to select desired scroll pattern

Scroll Chain Radius Chart								
								Standard No. of Spirals
	Min	Max	Min	Max	Min	Max		
SMALL Chain Part # CERCP	3/8" x 3/16"	3/4" x 1/4"	3/16" x 3/16"	1/4" x 1/4"	3/16"	1/4"	4-3/8"	2
MEDIUM Chain Part # CERCM	3/8" x 5/16"	1-1/2" x 5/16"	5/16" x 5/16"	3/8" x 3/8"	5/16"	5/16"	4-3/8"	3
LARGE Chain Part # CERCG	3/8" x 1/4"	1-3/16" x 3/8"	1/4" x 1/4"	5/8" x 5/8"	1/4"	5/8"	9-7/8"	2

Ships standard with Medium Scroll Chain

METALWORKING MACHINERY



Metalworking Machinery Table of Contents

- EP25H2-V2 Era Press horizontal hydraulic press.....98
- EP60 Era Press horizontal hydraulic press99
- Era Press EP25H2-V2 & EP60 tooling.....100-101
- Era Press Industrial Applications.....102
- Erco Flange EFB220103-104



METALWORKING MACHINERY





EP25H2-V2 Era Press

Horizontal Hydraulic Press



Part# EP25H2-V2 machine only



Capacities & Specifications

EP25H2-V2	
Tube Diameter:	3½" x .120
Max. Expansion / Reduction	(Tooling Dependent)
Square Tube	N/A
Folding Capacity - Steel Flat Bar	5" x ½"
Working Speed	½" – 1" sec.
Programming	Touchpad
Hydraulic Force	25 Tons
Horizontal Press	Yes
Maximum Stroke of Cylinder	6⅝"
Maximum Swage Depth	6" *
Voltage Requirement	220V/480V 3ph
Motor	3½ hp 50-60Hz
Motor Speed	3650 RPM
Length, Width, Height	41" x 29½" x 48"
Shipping Weight	1,675 lbs.

* Swage depth greater than 4½" requires special tooling – must be specified at time of order.

Contact CML USA for complete technical specifications. All capacities based on mild grade materials; heavy wall and high tensile materials reduce machine capacity.

25 Tons of Power

FEATURES

- Quick-change modular tooling
- Tooling available for tube flaring & flanging
- Utilizes punch-style swage tooling
- Performs metalworking press operations
- Programmable touchpad control with back-lit LCD display (8 program storage)
- Accurate controls of length of expansion or reduction or degree of fold with programmable cylinder stroke
- Expands and reduces tube and pipe ends
- Heavy-duty structure and rigid components
- Adjustable working speed and hydraulic force
- Remote pendant with low voltage controls
- Hydraulic material clamping system





EP60 Era Press

Horizontal Hydraulic Press

POWERFUL SWAGING AND METALWORKING PRESSES



Part# EP50H1 machine only



EP60 Touch Screen Control Panel

Capacities & Specifications

EP60	
Tube Diameter: Max. Expansion / Reduction	3½" - 4½" x .120
Square Tube	2½"
Folding Capacity - Steel Flat Bar	7⅞" x ¾"
Working Speed	Variable programmable
Programming	LCD touch screen
Hydraulic Force	60 Tons
Horizontal Press	Yes
Maximum Stroke of Cylinder	11½"
Maximum Swage Depth	8" **
Voltage Requirement	480V 3ph
Motor	8 hp 50-60Hz
Motor Speed	3650 RPM
Length, Width, Height	48" x 26" x 44"
Shipping Weight	2,300 lbs.

** Swage depth dependent on finger-style tools or standard reduction style – must be specified at time of order.

Contact CML USA for complete technical specifications. All capacities based on mild grade materials; heavy wall and high tensile materials reduce machine capacity.

60 Tons of Power

ADDITIONAL FEATURES ON EP60

- Swage square and rectangular tube
- Hand-held remote control certified class three safety
- LCD touch screen control
- **Unlimited** program storage with USB
- Utilizes punch or finger-style swage tooling
- **Energy saving** motor shuts off when not in use
- Optional side shift feature reduces tooling changeover

Product Demonstrations Available on Website

NEED ADDITIONAL HELP? CONTACT ERCOLINA:

563.391.7700

info@ercolina-usa.com

Era Press EP25H2-V2 Tooling

Tooling Included With EP25H2-V2



FEP25-0006-00
Expansion/Reduction
Holder



FEP25TI
Tube Expansion Tie Bar



FEP25-0007-00
Prism Holder



FEP25-0005-00
Straightening Supports



EPBM
Adjustable Stop



Era Press EP60 Tooling

Tooling Included With EP60



FEP60TI
Tube Expansion Tie Bar



FEP25-0007-00
Prism Holder

Finger-style Reduction Tooling for Tube, Pipe & Square for EP60



A100SPF
Reduction Cone Holder



Finger-Style Clamp
*(specify size
when ordering)*



Tapered Reduction Cone
*(specify size
when ordering)*

Diameter	Finger-Style Clamp for Tube & Pipe	Reduction Cone for Tube & Pipe
1"	HTR30-24	HTE20
1-1/4"	HTR32-26	HTE24
1-1/2"	HTR38-32	HTE32
1-3/4"	HTR46-40	HTE36
2"	HTR52-46	HTE42
2-1/4"	HTR58-52	HTE48
2-1/2"	HTR64-58	HTE54
2-3/4"	HTR70-64	HTE60
3"	HTR78-72	HTE68
3-1/2"	HTR88.9-82.6	HTE76.2
4"	HTR101.6-95.3	HTE95.3
4-1/2"	HTR114.3-108	HTE108

Diameter	Finger-Style Clamp for Square	Reduction Cone for Square
1"	*	*
1-1/4"	*	*
1-1/2"	*	*
2"	*	*

* Available on request



Bar Fold Tooling for EP25 and EP60



FEP2MS4V
Folding Prism
5/8" - 7/8" - 1 1/8"
& 2" Openings
Maximum Height 8"



FEP2MS85-80
Folding Prism
3 3/8" Opening
Max Capacity:
8" x 3/8" at 90°



FEP2MS80-140
Folding Prism
5 1/2" Opening
Max Capacity:
8" x 1/2" at 90°



FEPL60R10
Radius Folding Insert
10MM Radius
(Additional radii
available)



FEP25-0008-00
Flat Bar Folding Shaft
with Radius Insert Holder

Expansion / Reduction Tooling for EP25 and EP60



Expansion Punch
(specify size when ordering)



Reduction Cup
(specify size when ordering)



Clamp Jaw Set (set of 2)
(specify size when ordering)

Tube Sizes

Tube Size	Expansion Punch (EP25 & EP60)	Reduction Cup (EP25 & EP60)	Clamp Jaws (EP25)	Clamp Jaws (EP60)
1"	EP250E1T1000	EP250R1T1000	EP250G1T1000	EP60G1T1000
1-1/4"	EP250E1T1250	EP250R1T1250	EP250G1T1250	EP60G1T1250
1-1/2"	EP250E1T1500	EP250R1T1500	EP250G1T1500	EP60G1T1500
1-3/4"	EP250E1T1750	EP250R2T1750	EP250G1T1750	EP60G1T1750
2"	EP250E2T2000	EP250R2T2000	EP250G2T2000	EP60G2T2000
2-1/4"	EP250E2T2250	EP250R2T2250	EP250G2T2250	EP60G2T2250
2-1/2"	EP250E2T2500	EP250R2T2500	EP250G2T2500	EP60G2T2500
2-3/4"	EP250E2T2750	EP250R2T2750	EP250G2T2750	EP60G2T2750
3"	EP250E2T3000	EP250R2T3000	EP250G2T3000	EP60G2T3000
3-1/2"	EP250E2T3500	EP250R2T3500	EP250G2T3500	EP60G2T3500
EP60 Only				
4"	EP250E2T4000	EP250R2T4000	N/A	EP60G2T4000
4-1/2"	EP250E2T4500	EP250R2T4500	N/A	EP60G2T4500

Pipe Sizes

Pipe Size	Expansion Punch (EP25 & EP60)	Reduction Cup (EP25 & EP60)	Clamp Jaws (EP25)	Clamp Jaws (EP60)
1"	EP250E1P1000	EP250R1P1000	EP250G1P1000	EP60G1P1000
1-1/4"	EP250E1P1250	EP250R1P1250	EP250G1P1250	EP60G1P1250
1-1/2"	EP250E1P1500	EP250R1P1500	EP250G1P1500	EP60G1P1500
2"	EP250E2P2000	EP250R2P2000	EP250G2P2000	EP60G2P2000
2-1/2"	EP250E2P2500	EP250R2P2500	EP250G2P2500	EP60G2P2500
3"	EP250E2P3000	EP250R2P3000	EP250G2P3000	EP60G2P3000
EP60 Only				
4"	N/A	EP250R2P4000	N/A	EP60G2P4000



ERA PRESS

INDUSTRIAL APPLICATIONS

ERCOLINA HORIZONTAL HYDRAULIC PRESS

Ercolina's **EP25H2-V2** (25 ton hydraulic force) and **EP60** (60 ton hydraulic force) Era Press metalworking machines are programmable tube and pipe swaging machines and metalworking presses. Both models include standard tooling and offer optional tooling to form a wide variety of material.

Ercolina offers high quality equipment for a variety of industries around the globe.

Following is a partial list of industrial applications:

Swaging Tube & Pipe Reducing and Expanding

Furniture • Sports Equipment • Banner Displays •
Ground-mounted Radio Towers

Flaring & Flanging Applications

Refrigeration • Air Conditioning • Hydraulic Hoses • Plumbing

Press Brake Applications

Bar Folding • Mounting Brackets • L-Brackets • Tabs

Custom Applications

Tube Beading

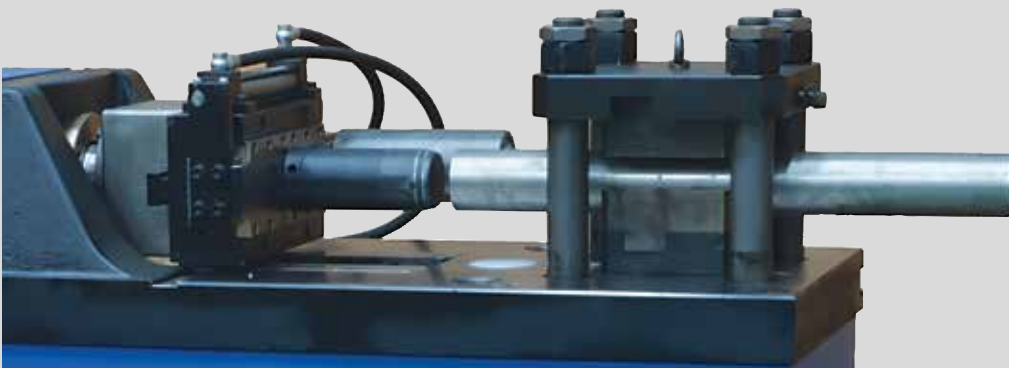



Erco Flange EFB220

Flanging Machine



Part# EFB220 machine only

TRADITIONAL FORMING SYSTEM MOST USED BY COMPETITORS

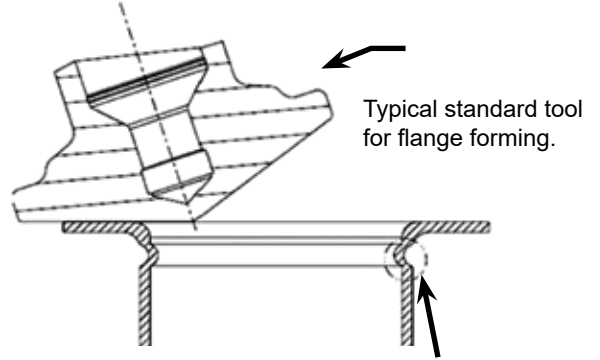

Main defect: collapsing of material around flange collar. Reduced tube diameter results in flow restriction.

ERCOLINA INNOVATIVE FORMING SYSTEM

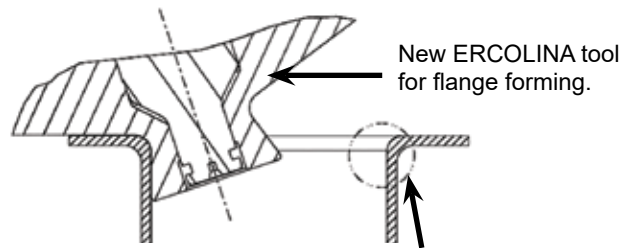

Thickness of material in area of flange radius may be increased. Gain in material at flange radius improves structural integrity.

Innovative Design Solves Flange Issues

FEATURES

- 37° and 90° flanges
- 8" gas max capacity
- PLC control, 5.7" touch screen
- Extremely easy setup
- Quick-change tooling
- Efficient: 30% cost reduction
- Heavy duty cast iron structure
- Double conical tools avoid swelling and deformation
- Consistent quality results



Ercolina's EFB uniformly cold forms a variety of materials including stainless, steel, copper and aluminum to 90° flanges in tubes with maximum wall thickness of .1875".

The innovative forming process uses a series of double conical tools to avoid swelling and deforming the flange.

Greater accuracy with minimum deformation results in less post-forming operations and higher productivity.

The EFB is equipped with a PLC control with 5.7" touch screen to easily control settings and machine operation.

Three types of tools for capacity from 3/4" to 8 1/2".



Erco Flange EFB220

Flanging Machine

Three types of tools for a range of capacity between D. 20 mm and D. 219.1 mm



Electronically positioned tool stop for quick - easy repeatable flanges

Typical Clamping Kit for ASTM 4" Gas Sch. 40 $\text{Ø} .114.3 \times 6 \text{ mm}$

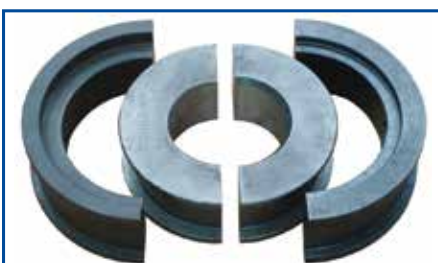

Clamp die interface kits necessary for flanging tube sizes $\text{Ø} 20 \text{ mm} - \text{Ø} 219.1 \text{ mm}$ supplied with machine.



Clamp dies sold separately to customer specifications.

ERCO-TECH DIRECT

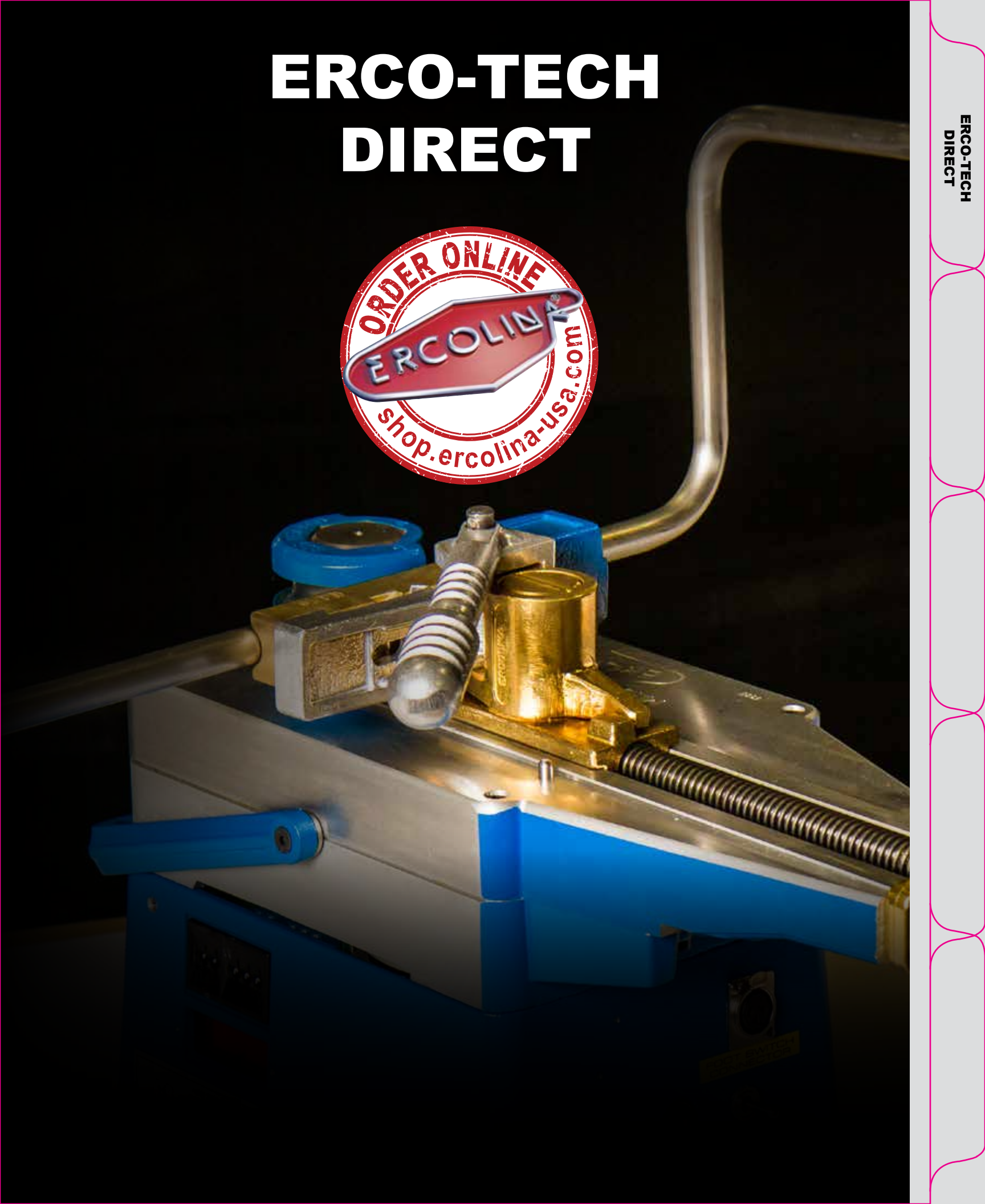

Erco-Tech Direct Table of Contents

- 070 Benchtap Model106
- 48 Plus107
- HB60 Hot Shot108
- Rotary draw tooling kits109
- CE35 Angle Roll110-111
- Angle Roll-Section Bender tooling sets112





070 Benchttop Model

Tube & Pipe Bending Machine

Bending... Made Simple

FEATURES

- Portable machine ideal for fabricators and contractors with job site bending applications
- Rotary dial setting for bend angle and springback
- Quick-change tooling system with multiple radii available
- Foot pedal control for hands-free operation
- Swing away counterbending die vise for easy material handling
- No hydraulic components
- Tripod base for on-site bending (optional)
- Includes carrying case

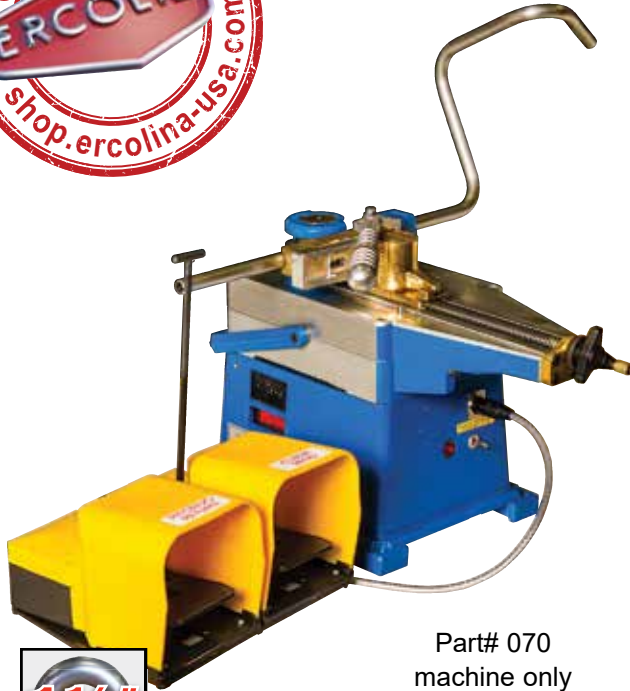

Part# 070
machine only



*Pipe and tube tooling sets available
online at shop.ercolina-usa.com*

070 Capacities & Specifications

Tube (Min.)	1/4"	1.9/10
(Max.)	1 1/4" - .065 wall	
Pipe (Max.)	1" Sch. 10	
Centerline Radius (Min.)	2 x Ø	
(Max.)	6 7/8"	
Degree of Bend	0-210°	
Bending Speed	2.2 RPM	
Programming	Rotary Dial with LED	
Voltage	120V 1ph (220V available)	
Length, Width, Height	10" x 13" x 18"	
Weight	60 lbs.	



Tube & Pipe Bending Machine Practical One-Touch Control

FEATURES

- Ideal for producing consistent quality bends in pipe, tube, squares, solids and other profiles
- Easy one touch control allows any operator to program and automatically store bend angle
- Large easy to read color coded control displays all current information in real time
- Separate display of material springback for greater accuracy on a variety of materials
- Bend any angle to 180° with independent material springback compensation for each bend
- Single bending speed
- Initiate bend cycle from the control panel or included foot pedal
- Quick-change tooling system with multiple radii available
- Swing away counterbending die vise for easy material handling
- Accepts Ercolina's A40-P two axis positioning table for multiple and sequential bends
- Classic Ercolina bender design reduces space requirement and stores easily to save shop floor space
- Operates from single phase 220 volts for greater convenience and efficiency
- No hydraulic components



Part# SB48PLUS machine only



Tube Capacity



Pipe and tube tooling sets available online at shop.ercolina-usa.com

48 Plus Capacities & Specifications

Tube (Min.)	1/4"	6/16
(Max.)	2"	
Pipe (Max.)	1 1/2" Sch. 40	
Centerline Radius (Min.)	2 x Ø	
(Max.)	8 7/8"	
Degree of Bend	0-210°	
Bending Speed	2 RPM	
Programming	One touch bend angle control with springback	
Material Positioning Table	Available	
Voltage	220V 1ph	
Length, Width, Height	22 1/2" x 16 1/4" x 39 1/2"	
Weight	300 lbs.	

All capacities based on A53 grade A 48,000 psi tensile materials; heavy wall and high tensile materials reduce machine capacity. Consult supplier for material specifications.



HB60 Hot Shot

Tube & Pipe Bending Machine

Tube Bending Made Easy

FEATURES

- Ideal for producing tight radius consistent quality bends in pipe, tube and solids. **Note:** Bending square tube requires tooling modified for crush style bends for easy removal after the bend.
- Hybrid hydraulic gear driven rotary draw bend action
- Quickly bend to 180° in seconds with patented ergonomic function - no ratcheting or repositioning
- Easy set and view angle degree wheel with auto stop for repeatable bends
- Draws tube from one direction for easier sequential bending
- Swing away counter bending die vise allows easy material on and off maintaining position without secondary locking
- Patented quick change system accepts all Ercolina tooling
- Precision one-piece cast steel tooling available in multiple centerline radii accommodates a variety of materials and wall thicknesses
- One piece solid bronze counter bend die for longer tool life and rigid support throughout the bend
- Machine case engineered for strength with high section modulus design
- Bend head swivels to accommodate any size shop space
- Single or three phase electric power available



Part# HB60-M2
machine only
PATENT PENDING

Pipe and tube tooling sets available
online at shop.ercolina-usa.com

HB60 Capacities & Specifications



Degree wheel for repeatable bending angles

Tube (Min.)	1/4"	10/20
(Max.)	2"	
Pipe (Max.)	1 1/2" Sch. 40	
Centerline Radius (Min.)	2 x Ø	
(Max.)	10.5"	
Degree of Bend	0-180°	
Bending Speed	1.5 RPM	
Voltage – HB60-M2	120V 1ph	
HB60-T	480V 3ph	
Length, Width, Height	27" x 15" x 36"	
Weight	290 lbs.	

All capacities based on A53 grade A 48,000 psi tensile materials; heavy wall and high tensile materials reduce machine capacity.
Consult supplier for material specifications.



Save with Rotary Draw Tooling Kits

(Additional Savings when Purchased with Machine)

Individual tooling available for pipe, round and square tube available online at shop.ercolina-usa.com.



	Description	Material Size	Centerline Radius - Inches -	Min. Wall	Center Former Part#	Counterhead Die Part#	Available with Ercolina Machines
PIPE	PIPEKIT2	1/2"	1.8	.109	153R046P0500	155P0500	48 Plus, HB60
		3/4"	2.2	.113	153R056P0750	155P0750	
		1"	2.6	.133	153R067P1000	155P1000	
		1 1/4"	3.5	.140	153R090P1250	155P1250	
		1 1/2"	3.9	.145	153R100P1500	155P1500	
	PIPEKIT3	1/2"	1.8	.109	153R046P0500	155P0500	070 Medi Bender
		3/4"	2.2	.113	153R056P0750	155P0750	
		1"	2.6	.133	153R067P1000	155P1000	
	Handrail Pipe Kit	1 1/4"	3.5	.140	153R090P1250	155P1250	48 Plus
		1 1/2"	3.9	.145	153R100P1500	155P1500	
TUBE	Small Radius Tube Kit TUBEKIT2SR	3/4"	2.6	.035	153R067T0750	154T0750	48 Plus, HB60
		7/8"	2.2	.065	153R056T0875	154T0875	
		1"	2.6	.065	153R067T1000	154T1000	
		1 1/4"	3.2	.083	153R082T1250	154T1250	
		1 1/2"	3.9	.083	153R100T1500	154T1500	
	Large Radius Tube Kit TUBEKIT2	3/4"	2.6	.035	153R067T0750	154T0750	48 Plus, HB60
		7/8"	2.6	.035	153R067T0875	154T0875	
		1"	3.2	.035	153R082T1000	154T1000	
		1 1/4"	4.4	.035	153R112T1250	154T1250	
		1 1/2"	5.9	.049	153R150T1500	154T1500	
		1 3/4"	6.7	.065	153R170T1750	154T1750	
	TUBEKIT3	1/2"	1.4	.035	153R036T0500	154T0500	070 Medi Bender
		3/4"	2.6	.035	153R067T0750	154T0750	
		1"	2.6	.065	153R067T1000	154T1000	

Refer to machine specifications for individual capacities.



CE35 Angle Roll

Manual Angle Roll • Section Bender

6/5

Capacities & Specifications

Pipe (Max.)	1½" Sch. 40
Angle (Max.)	1½" x 1½" x ¼"
Tube (Max.)	2" – .156 wall
Roll Shaft Diameter	40mm
Center Roll Positioning	Manual
Shaft Speed	6 or 12 RPM
Universal Tooling (Included)	6⅝" O.D.
Programming	Not available
Distance between Shafts	11⅜"
Operating Voltage	220V 1ph
Length, Width, Height	27½" x 25½" x 59"

All capacities based on mild grade materials; heavy wall and high tensile materials reduce machine capacity.

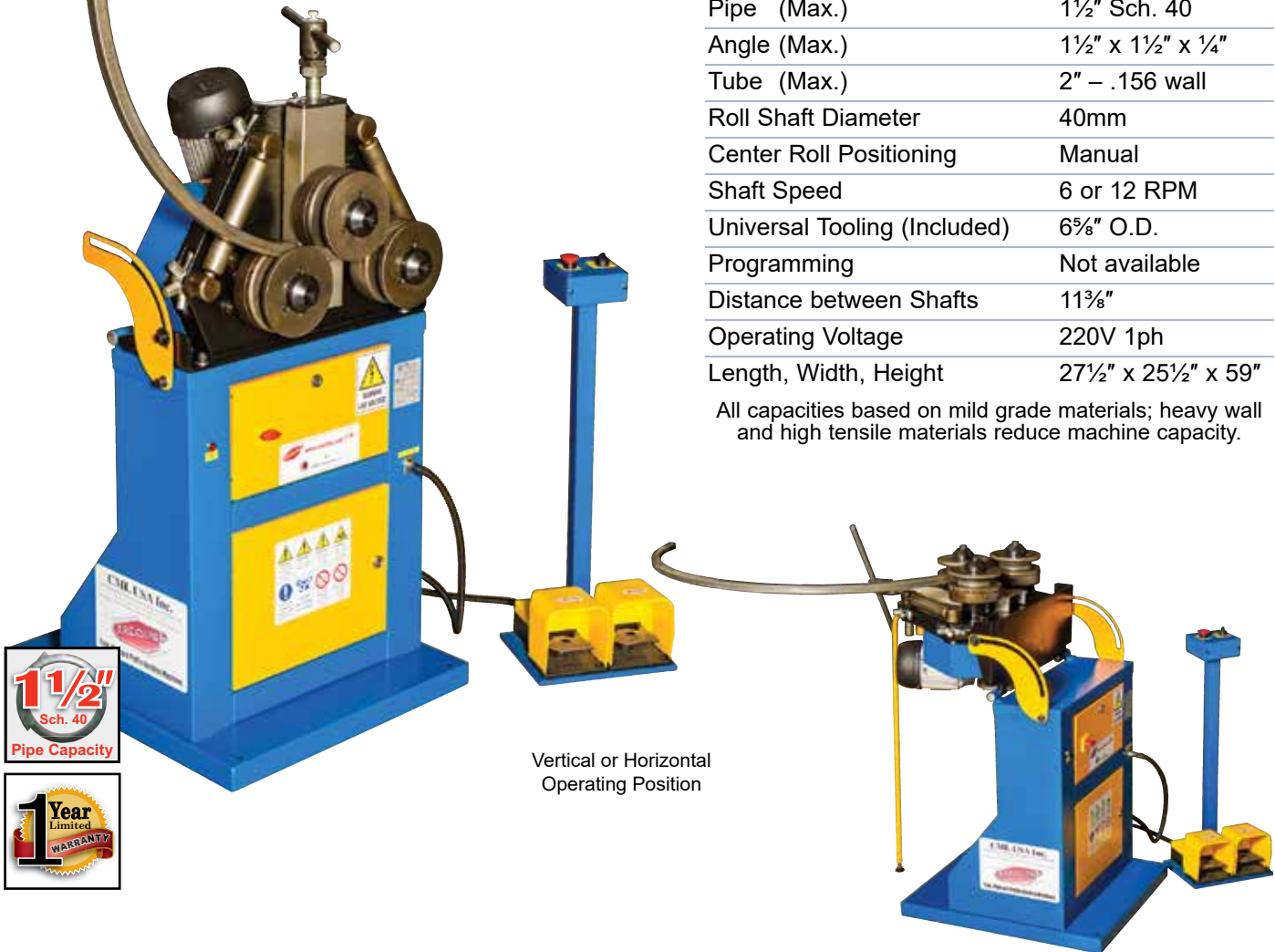

Vertical or Horizontal Operating Position

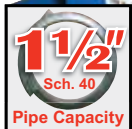

Convenient Single Phase Power

FEATURES

- 40mm roll shaft diameter
- Universal tooling set included with each machine
- Forged roll shafts precision ground and fitted for maximum performance and minimal deflection
- Roll shafts supported with conical steel bearings on each side of A Frame
- Heavy duty structure and rigid components for high section modulus ratings
- Two bending speeds
- Reinforced engineered mainframe design proven to outperform competitive models
- Heavy duty gearbox drives lower roll shafts
- Threaded roll shafts with micrometric flange adjustment helps eliminate spacer usage
- Control tower with foot pedal operation of roll movement
- Optional anti-twist correction system required for angle iron "Leg In" applications



Minimum Radius Guide on Mild Steel Material

Small Radius Tooling

Adjustable tooling set for small radius bending applications.

Tooling Material Capacities

Profile	Maximum
Square solids	5/8" x 5/8"
Rectangular solids	3/4" x 1/4"
Rounds	5/8"
T Stock	3/4" x 3/4"

Part# C4RR fits CE35



Anti-Twist Device

Required for Angle iron "Leg In" applications.
Part# CEA4-ECO40 fits CE35

Profile Type	CE35		
	Profile Dimensions	Min. CLR Inches	Wall
Pipe	1/2"	6	.109
	1"	10	.133
	1 1/4"	15	.140
Tube	1"	6	.120
	1 1/2"	12	.120
	2"	16	.095
Square Tube	3/4" x 3/4"	8	.065
	1 1/2" x 1 1/2"	18	.120
Rectangular Tube Hard way	3/8" x 1"	10	.065
	1/2" x 1 1/4"	14	.095
Rectangular Tube Easy way	1" x 3/8"	10	.065
	1 1/4" x 1/2"	18	.095
Round Solid	3/4"	4*	NA
Square Solid	5/8"	4*	NA
	1"	8	NA
Rectangular Solid Hard way	3/8" x 1 1/4"	8	NA
	3/8" x 1 1/2"	10	NA
Rectangular Solid Easy way	1 1/4" x 3/8"	6	NA
	1 1/2" x 3/8"	8	NA
Angle "Leg Out"	1" x 1"	8	.125
	1 1/2" x 1 1/2"	16	.187
Angle "Leg In"	1" x 1"	10	.125
	1 1/2" x 1 1/2"	18	.187
C "Leg Out"	1 1/4" x 1/2"	8	.187
C "Leg In"	1 1/2" x 3/4"	8	.187

*Special tooling required



Angle Roll-Section Bender Tooling Sets

PIPE			TUBE		
Size	O.D.	Part#	Size	O.D.	Part#
½"	.840	C4SPD2**	¾"	.750	C401T0750
¾"	1.050	C4SPD1**	1"	1.000	C401T1000
1"	1.315	C4SPD1**	1¼"	1.250	C401T1250
1¼"	1.660	C4SPD2**	1⅝"	1.375	C401T1375
1½"	1.900	C401P1500	1½"	1.500	C401T1500
** Combination Twin Tool Sets Consult factory for tooling sizes not shown.			1⅞"	1.625	C401T1625
			1¾"	1.750	C401T1750
			1⅞"	1.875	C401T1875
			2"	2.000	C401T2000

All Ercolina angle roll-section bending machines **include** universal tooling sets. Universal tooling adjusts easily to bend the following profiles:

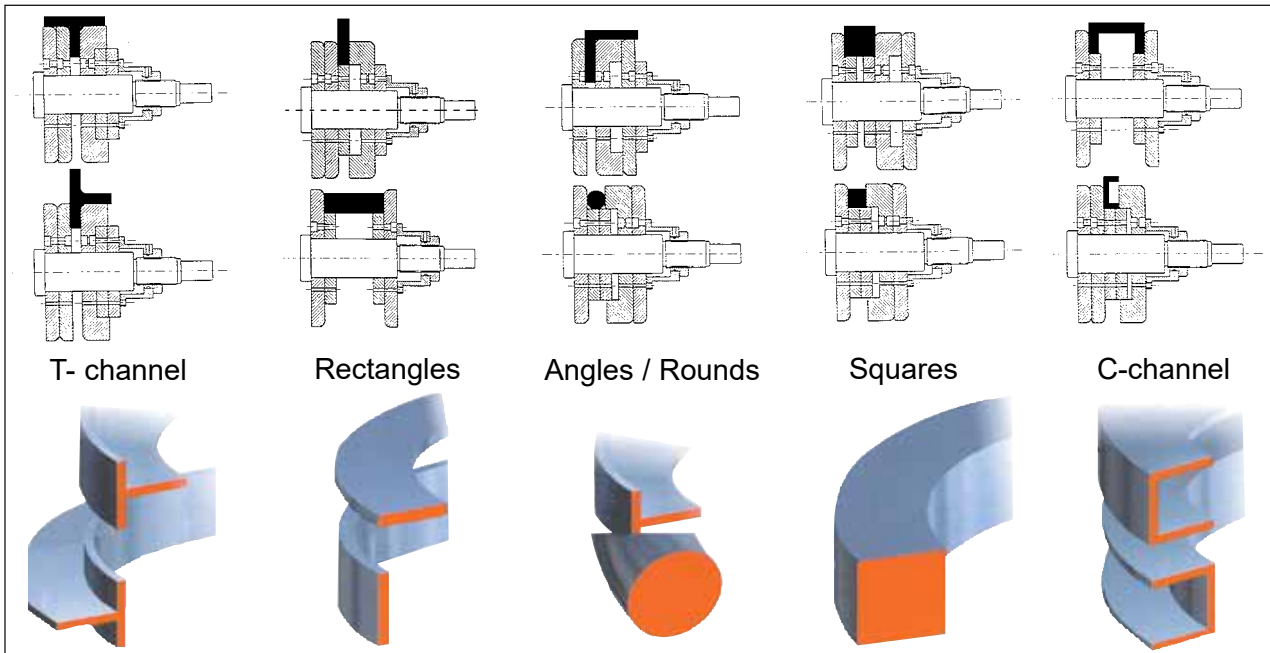

Universal Tooling Set

HIGH-SPEED ELECTRIC MANDREL BENDERS



PEDRAZZOLI

HIGH-SPEED ELECTRIC
MANDREL BENDERS

High-Speed Electric Mandrel Benders Table of Contents

● Model selection chart	114-115
● Bend Master 45	116
● Bend Master 65	117
● Bend Master 90	118
● Bend Master 38	119
● Intelligent Motion System (IMS)	120





Model Selection Chart

CW: Clockwise CCW: Counter Clockwise

		Specifications		
Capacity	BM38 1.5" x .095	BM45 1.75" x .118	BM65 2.5" x .083	BM90 3.5" x .157
CW and/or CCW Bending	Right Left Independent	Yes	Yes	CW
Maximum CLR CW	6"	6"	9.8"	15.7"
Maximum CLR CW-CCW	NA	6"	9.4"	NA
Minimum Inside Radius with Standard Spindle	1.2"	1.57"	1.87"	1.77"
Variable Radius Bending	Yes	Yes	Yes	Yes
Maximum Bend Angle	180°	190°/182°	187°/183°	190°
Min. Distance Between Bends	0.5 x Diameter	1.5-2 x Diameter	1.5-2 x Diameter	1.5-2 x Diameter
Max. Distance Between Bends	204"	NA	NA	NA
Max. Stroke Clamp Die	3.15"	4.35"	8"	6"
Max. Stroke Mandrel	Machine without Mandrel	6"	6"	29"

Specifications	BM38	BM45	BM65	BM90
Section Modulus cm ³	2.33	3.9	6.6	22.25
Horizontal Head Travel	19.6"	14.2"	20"	16.1"
Vertical Head Travel	NA	11.4"	11.8"	11.8"
Number of Bend Heads	2	1	1	1
Punching	Available	Available	Available	Not Available
Electrically Controlled Axes	8	10 + 1 optional	10 + 1 optional	6
Drive Controllers	FANUC	FANUC	FANUC	FANUC
Precision of Electric Axis	+ or - .1 mm	+ or - .05 mm	+ or - .05 mm	+ or - .1 mm
Carriage Speed	32.8" / min	36" / sec	28" / sec	28" / sec
Bend Arm Speed	160° / sec	200° / sec	99° / sec	64° / sec
Tube Rotation Speed	NA	600° / sec	600° / sec	287° / sec
Central Clamp Rotation	250° / sec	NA	NA	NA
Maximum Tool Stacks	2-3	3+	3+	3+
Software	IMS	IMS	IMS	IMS
Webcam	Yes	Yes	Yes	Yes
Max. Tube Length on Front Stop	204"	118"	159"	157"
Max. Tube Length on Rear Stop	NA	181"	224"	212"
Machine Dimensions	257" x 78" x 57"	244" x 55" x 66"	298" x 67" x 75"	314" x 92" x 77"
Height of Work Plane	47"	43"	48"	52"
Weight	8,400 lbs	6,840 lbs	10,360 lbs	16,314 lbs
Power	480V 53kw	480V 22kw	480V 50kw	480V 50kw
Hydraulic Reservoir	39 gallons	NA	NA	79 gallons



Unveiling the innovation of the Pedrazzoli Bend Master 45, where electric axis control seamlessly orchestrates both clockwise and counter-clockwise bending within a single cycle. Elevate your metal fabrication with the unique multi-stack tooling design, empowering the creation of bends with precision in fixed or variable radii. Crafted from the finest high-grade steel, the machine's foundation guarantees enduring performance.

Every intricate part of the Bend Master 45 undergoes meticulous machining, adhering to exacting standards, with dimensions validated by state-of-the-art measuring systems. Experience flawlessly fluid linear guide movements, enhanced by re-circulating ball spheres, brushless motors, and an unwavering mechanical architecture. Immerse yourself in unparalleled accuracy, further amplified by the inclusion of a tool post strengthening tie rod.

KEY FEATURES

- Clockwise and counter-clockwise bending
- Variable and multi-radius bending in the same cycle
- Compact bending head design accommodates most applications
- Intuitive IMS touchscreen control
- Electric axis for greater precision
- FANUC drive controllers for improved reliability
- Innovative tube stop allows positioning from rear of carriage (optional)
- Boost for tight radius bending with synchronized control of axis
- Automatic adjustment of tools
- Torque controlled positioning of carriage on incline tooth precision gear rack
- Controlled torque of clamp die and pressure die
- Automatic lubrication work piece
- Rapid coupling system for quick mandrel rod installation
- Safety light barriers with programmable work zone
- Central lubrication of guides and ball screws
- Integrated part handling options available



Elevate your metal bending mastery with the Pedrazzoli Bend Master 65, boasting an innovative electric axis control that seamlessly orchestrates clockwise and counter-clockwise bends within a single cycle. Unlock limitless possibilities with the ingenious multi-stack tooling design, engineered to craft bends of impeccable precision in both fixed and variable radii. Crafted from the pinnacle of high-grade steel, the machine's robust framework ensures unwavering performance.

Every minuscule detail of the Bend Master 65 undergoes meticulous machining, adhering to the most stringent standards. Dimensions are not just measured but certified by cutting-edge measuring systems, guaranteeing excellence. Glide through your projects with unparalleled fluidity as the linear guide movements incorporate re-circulating ball spheres, brushless motors, and a steadfast mechanical architecture. And to elevate precision even further, a tool post strengthening tie rod is thoughtfully integrated, setting a new standard for accuracy.

KEY FEATURES

- Clockwise and counter-clockwise bending
- Variable and multi-radius bending in the same cycle
- Compact bending head design accommodates most applications
- Intuitive IMS touchscreen control
- Electric axis for greater precision
- FANUC drive controllers for improved reliability
- Innovative tube stop allows positioning from rear of carriage (optional)
- Boost for tight radius bending with synchronized control of axis
- Automatic adjustment of tools
- Torque controlled positioning of carriage on incline tooth precision gear rack
- Controlled torque of clamp die and pressure die
- Automatic lubrication work piece
- Rapid coupling system for quick mandrel rod installation
- Safety light barriers with programmable work zone
- Central lubrication of guides and ball screws
- Integrated part handling options available

High-Speed Electric Mandrel Bender



Introducing the Pedrazzoli Bend Master 90, where precision meets innovation. With its cutting-edge electric axis control, experience flawless clockwise bends within a single cycle. The versatile multi-stack tooling design crafts impeccable fixed or variable radius bends, setting new standards for metal fabrication. Crafted from the finest high-grade steel, the Bend Master 90 machine's foundation promises longevity and unwavering performance.

Meticulous craftsmanship defines every component of the Bend Master 90, adhering rigorously to exacting standards. Dimensions aren't just measured – they are certified through state-of-the-art measuring systems, guaranteeing unrivaled accuracy. Delight in seamless linear guide movements, empowered by re-circulating ball spheres, brushless motors, and an unyielding mechanical structure. Elevating precision to new heights, the integrated tool post strengthening tie rod ensures your projects are nothing short of perfection.

KEY FEATURES

- Clockwise bending
- Variable and multi-radius bending in the same cycle
- Compact bending head design accommodates most applications
- Intuitive IMS touchscreen control
- Electric axis for greater precision
- FANUC drive controllers for improved reliability
- Innovative tube stop allows positioning from rear of carriage (optional)
- Boost for tight radius bending with synchronized control of axis
- Automatic adjustment of tools
- Torque controlled positioning of carriage on incline tooth precision gear rack
- Controlled torque of clamp die and pressure die
- Automatic lubrication work piece
- Rapid coupling system for quick mandrel rod installation
- Safety light barriers with programmable work zone
- Central lubrication of guides and ball screws
- Integrated part handling options available

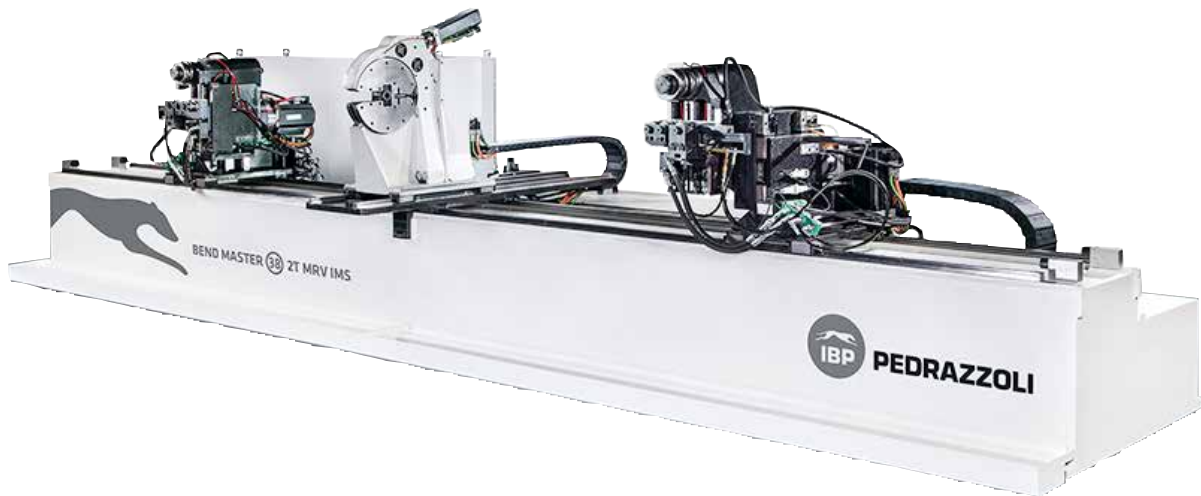

Introducing the Pedrazzoli Bend Master 38, featuring advanced electric axis control enabling simultaneous clockwise and counter-clockwise bending in a single cycle. Its ingenious multi-stack tooling design excels in creating both fixed and variable radius bends. Crafted from top-tier steel, the machine's framework guarantees durability.

Every element of the Bend Master 38 is meticulously machined to precise standards, with dimensions verified by cutting-edge measuring systems. The linear guide movements showcase re-circulating ball spheres, brushless motors, and a robust mechanical composition. For better precision, a tool post strengthening tie rod is included.

KEY FEATURES

- Clockwise and counter-clockwise bending
- Variable and multi-radius bending in the same cycle
- Compact bending head design accommodates most applications
- Intuitive IMS touchscreen control
- Electric axis for greater precision
- FANUC drive controllers for improved reliability
- Innovative tube stop allows positioning from rear of carriage (optional)
- Boost for tight radius bending with synchronized control of axis
- Automatic adjustment of tools
- Torque controlled positioning of carriage on incline tooth precision gear rack
- Controlled torque of clamp die and pressure die
- Automatic lubrication work piece
- Rapid coupling system for quick mandrel rod installation
- Safety light barriers with programmable work zone
- Central lubrication of guides and ball screws
- Integrated part handling options available

Features and benefits of Pedrazzoli Intelligent Motion System (IMS)

Introducing Pedrazzoli's highly flexible Intelligent Motion System (IMS) program with touch screen designed for intuitive user-friendly operation with three-dimensional graphic programming of our machines. Quickly create, control and execute new programs in minutes. IMS represents a single solution for operating and managing bending, end forming processes. Effectively enhancing operator training and improving productivity.



Simulation mode immediately analyzes work piece feasibility, optimizes production time and advises of possible interference.

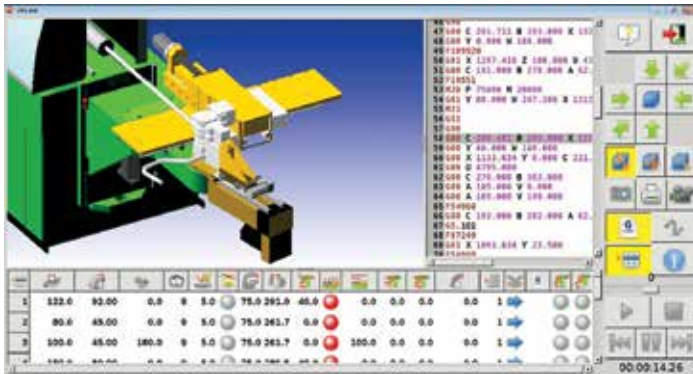

Easily manage all machine axis within predefined safety area, ideal for optimizing tool testing and programming of machine sequences during setup. Input data directly to machine or import of 3D drawing to assist in creating machine cycle. Accepts XYZ or Cartesian coordinates with conversion.

Automatic generation and optimization of symmetrical or mirror parts. Automatic generation of G-code to FANUC NC.

G-code accessibility allows operator to modify data, sequence, and machine cycle.

Control each program step, axis speed, simultaneous movement, mandrel extraction, lubrication functions.

Tooling page displays tooling description and settings for slide thrust, carriage movement, loading, bend die and more.

Manual movement page allows complete control of single jog, axis speed and overall cycle movement during setup. Ideal for prototype work.

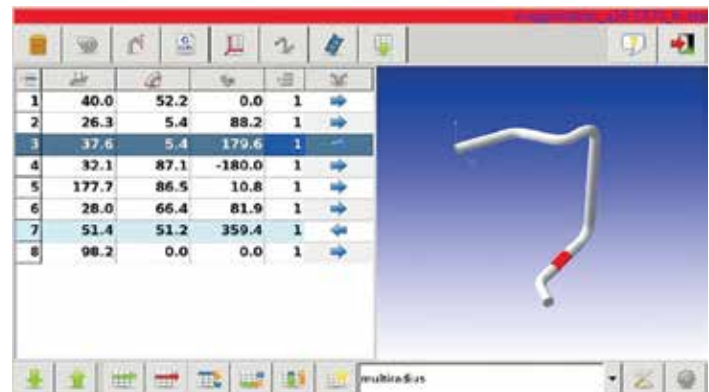

Importation of IGES files

- IMS OFFICE package offline programming of work cycle, shares programs and data between Pedrazzoli machines creating a single access drive
- Easily recall programs visually by scrolling through directory
- IMS platform available for PC, Tablet and Smart-phone

- Designed to fully advantage included FANUC drives offering maximum reliability, reducing connections, while providing detailed diagnostics
- Monitor axis functions including position, speed, torque, temperature and calibration with graphic visualization during the bend

ELECTRO-HYDRAULIC END FORMING MACHINES



PEDRAZZOLI

Electro-Hydraulic End Forming Machines Table of Contents

● Model selection chart	122
● Stern Brown 25.....	123
● Stern Brown 50.....	124
● Stern Brown 80.....	125
● Stern Brown 160.....	126
● Electro-hydraulic end forming machines	127-128





PEDRAZZOLI
Model Selection
Chart



Specifications	Stern 25	Stern 50	Stern 80	Stern 160
Maximum Diameter	1.375"	2.125"	3.375"	6.5"
Maximum Wall Thickness	.118"	.156"	.156"	.196"
Maximum End Form Depth	5.9"	6.7"	7.9"	7.1"
Electrically Controlled Axes	3	4	3	3
Powered Tool Stations	15	15	12	12
End Form Speed	5.5"/sec	4.2"/sec	2.62"/sec	2.81"/sec
Positioning Precision	.05 mm	.05 mm	.05 mm	.05 mm
Working Thrust	80 kN	150kN	250 kN	500 kN
Tool Disk Rotation Torque	12 Nm	12 Nm	12 Nm	12 Nm
Vise Clamp Force	5,388 kg	23,000 kg	NA	80,000 kg
Clamp Holding Force	120 kN	230 kN	380 kN	800 kN
Jaw Length	4.25"	6.7"	7.9"	9.45"
Maximum Jaw Open	2.12"	2.16"	3.5"	6.4"
Maximum Work Unit Travel	7"	11.8"	15.7"	15.7"
Standard Tool Block Dimension	7.7"	7.7"	6.9"	6.9"
Software	IMS	IMS	IMS	IMS
Webcam	Yes	Yes	Yes	Yes
Machine Dimensions	95" x 58" x 67"	95" x 58" x 67"	122" x 73" x 67"	142" x 87" x 77"
Weight	4,000 lbs	5,500 lbs	9,900 lbs	19,800 lbs
Power	480V 16.5kw	480V 16.5kw	480V 16.5kw	480V 25kw
Hydraulic Reservoir	30 gallons	24 gallons	30 gallons	80 gallons

Electro-Hydraulic End Forming Machine



Experience the future of end forming with Stern Brown 25 end forming machine. Our end formers are equipped with the cutting-edge Pedrazzoli IMS (Intelligent Motion Software), enabling precise control over end forming operations. Visualize, create, and execute programs effortlessly via touchscreen, while remote design and network download options offer unparalleled convenience.

Seamlessly program single or multiple tool stations and define working sequences with ease. The manual movement page provides intuitive tooling selection and variable speed jogging, perfect for setup and prototyping. With a generous control memory storing up to 10,000 programs, Stern Brown empowers you to shape the future of manufacturing.

KEY FEATURES

- Three axis with digital absolute brushless motors control tooling rotation, turret rotation, and tooling advance
- Working motion driven with ball screw and bearing designed for heavy loads
- Linear forming and machining with Hydraulic movement
- Up to fifteen work tooling stations
- All tooling stations are capable of rotation for 360° end forming
- Tool stations rotate to machine center for greatest efficiency and faster tool changes
- Vise feature manual opening lever for pre-clamping of various part shapes
- Clamping units designed to work in tandem or independently
- Webcam for remote assistance
- User-friendly IMS software
- Requires minimum floor space

Electro-Hydraulic End Forming Machine



Unleash the power of innovation with Stern Brown's signature edge – our Stern Brown 50 end forming machine is integrated with Pedrazzoli IMS (Intelligent Motion Software). Precision and control take center stage as this software empowers operators to visualize, craft, replicate, and execute end forming programs, all through a user-friendly touchscreen interface.

Elevating convenience further, we offer remote design and network download options upon request. Tailor your processes by programming single or multiple tool stations and choreographing seamless working sequences. For precise setups and experimental phases, our manual movement page grants on-screen tooling selection and jog control with variable speeds.

Redefining the horizon of manufacturing, the Stern Brown 50 holds up to 10,000 programs in its control memory, underscoring our commitment to shaping a dynamic future.

KEY FEATURES

- Three axis with digital absolute brushless motors control tooling rotation, turret rotation, and tooling advance
- Working motion driven with ball screw and bearing designed for heavy loads
- Linear forming and machining with Hydraulic movement
- Up to fifteen work tooling stations
- All tooling stations are capable of rotation for 360° end forming
- Tool stations rotate to machine center for greatest efficiency and faster tool changes
- Vise feature manual opening lever for pre-clamping of various part shapes
- Clamping units designed to work in tandem or independently
- Webcam for remote assistance
- User-friendly IMS software
- Requires minimum floor space

Electro-Hydraulic End Forming Machine



At the heart of Stern Brown's excellence lies our hallmark feature – Pedrazzoli IMS (Intelligent Motion Software) integrated into every end former. Precision engineering merges seamlessly with intuitive control, granting operators the power to visualize, construct, replicate, and execute end forming programs effortlessly via touchscreen interaction.

Experience the future of production convenience with optional remote design and network download services. Craft tailored sequences by programming single or multiple tool stations, choreographing every step of the process. Our manual movement page is a canvas for precision, allowing on-screen tooling selection and jog control with customizable speed – a haven for setup perfection and prototype exploration.

With a vast control memory, the Stern Brown 80 end forming machine, stores up to 10,000 programs. Stern Brown redefines manufacturing possibilities. Discover the epitome of innovation, setting new benchmarks in end forming technology.

KEY FEATURES

- Three axis with digital absolute brushless motors control tooling rotation, turret rotation, and tooling advance
- Working motion driven with ball screw and bearing designed for heavy loads
- Linear forming and machining with Hydraulic movement
- Up to twelve work tooling stations
- All tooling stations are capable of rotation for 360° end forming
- Tool stations rotate to machine center for greatest efficiency and faster tool changes
- Vise feature manual opening lever for pre-clamping of various part shapes
- Clamping units designed to work in tandem or independently
- Webcam for remote assistance
- User-friendly IMS software
- Requires minimum floor space

Electro-Hydraulic End Forming Machine



The Stern Brown 160 end former is equipped with Pedrazzoli IMS (Intelligent Motion Software) developed for controlling end forming operations. Software allows operator to visualize part, create, copy and execute program via touchscreen.

Remote design, and download from network available on request. Program single or multiple tool stations and working sequence. Manual movement page enables on screen selection of tooling, jogging with variable speed control, ideal for setup and prototype work. Control memory stored up to 10,000 programs.

KEY FEATURES

- Three axis with digital absolute brushless motors control tooling rotation, turret rotation, and tooling advance
- Working motion driven with ball screw and bearing designed for heavy loads
- Linear forming and machining with Hydraulic movement
- Up to twelve work tooling stations
- All tooling stations are capable of rotation for 360° end forming
- Tool stations rotate to machine center for greatest efficiency and faster tool changes
- Vise feature manual opening lever for pre-clamping of various part shapes
- Clamping units designed to work in tandem or independently
- Webcam for remote assistance
- User-friendly IMS software
- Requires minimum floor space



Electro-Hydraulic End Forming Machines

Pedrazzoli Stern Brown electric end forming machine series proven reliable design produces multiple forming and machining operations to the work piece in one cycle. Highly flexible intuitive IMS software combines with the reliability of FANUC drives controllers accurately producing parts with minimum maintenance. Machine base manufactured from nodular cast iron for greater overall machine stability. Automatic working optimization of tooling turret movement features up to 15 powered workstations capable of expanding, reducing, end forming, beading, facing, chamfering, closing, threading, tapping, flaring and more. Integrate with Bend Master electric series tube bending machines for greater productivity.





SAW LINES























PEDRAZZOLI

Saw Lines Table of Contents













- Model selection chart130-131
- Super Brown 350/60 MRM Manual Circular Cold Saw132
- Super Brown 350/60 SA Semiautomatic Circular Saw with pneumatic vise133
- Super Brown 350 AP Semiautomatic Circular Cold Saw with feeder & pneumatic vise134
- Perris 350 SA Semiautomatic High-Speed Aluminum Cutting Circular Saw with pneumatic vise135
- Cold saw blades136-141
- SN 300 Newton Manual Band Saw142
- Brown SN 420 SA Semiautomatic Band Saw Variable Speed Control143-145
- Band Saw features146
- Band Saw blade information147
- HB 450 SA Semiautomatic Circular Upcut Saw148-151
- Notes152









CIRCULAR SAWS

Cutting Capacity		 45°	 0°	 45°	 60°
 <p>Super Brown 350/60 MRM Manual Circular Cold Saw</p>		4"	4"	4"	4"
		3.5"	3.3"	3.5"	2.8"
		4.7" x 2.4"	6.2" x 3.3"	4.7" x 3.3"	3.1" x 2.8"
 <p>Super Brown 350/60 SA Semiautomatic Circular Cold Saw with Pneumatic Vise</p>		4"	4"	4"	4"
		3.5"	3.3"	3.5"	2.8"
		4.7" x 2.4"	6.2" x 3.3"	4.7" x 3.3"	3.1" x 2.8"
 <p>Super Brown 350 AP Semiautomatic Circular Cold Saw with Feeder & Pneumatic Vise</p>		-	4"	4"	-
		-	3.3"	3.5"	-
		-	6.2" x 3.3"	4.7" x 3.3"	-
 <p>Perris 350 SA Semiautomatic High-Speed Aluminum Cutting Circular Saw with Pneumatic Vise</p>		3.7"	3.9"	3.7"	2.4" 45° off vertical
		3.7"	3.7"	3.5"	2.4" 45° off vertical
		5.1" x 2.2"	6.1" x 2.4"	5.1" x 2.2"	5.9" x 1.6"

BAND SAWS

Cutting Capacity		 45°	 0°	 45°	 60°
 <p>SN 300 Newton Manual Band Saw</p>		6.3"	8.7"	7.9"	5.1"
		4.7"	7.5"	5.9"	4.3"
		6.3" x 5.1"	13" x 5.9"	4.7" x 5.1"	4.3" x 4.3"
 <p>Brown SN 420 SA Semiautomatic Band Saw Variable Speed Control</p>		6.7"	11"	9.1"	5.9"
		5.9"	10.6"	8.7"	5.9"
		9.4" x 3.5"	16.5" x 7.5"	9.1" x 5.9"	3.1" x 2.8"

CIRCULAR UPCUT SAW

Cutting Capacity		 45°	 0°	 45°	 60°
 <p>HB 450 SA Semiautomatic Circular Upcut Saw</p>		5.9"	5.9"	5.9"	5.3"
		4.7"	5.1"	4.7"	4.3"

MACHINE DESCRIPTION:

Introducing Pedrazzoli's classic workhorse circular cold saw, the original Super Brown 350. Ideal for any fabrication shop wanting safe, quick sawing of ferrous or nonferrous tube, pipe and profiles with minimum clean up. All Pedrazzoli saws feature robust heavy-duty cast iron bases that minimize vibration during the cutting cycle. Work head adjusts to miter right or left and locks securely in place. Manual vise with rapid clamp feature and anti-burr device firmly supports the material throughout the cut providing burr free parts with no heat transfer. Proven machine design provides a smooth sawing operation and outstanding reliability. Manufactured and assembled with years of fabrication experience.



Features:

- > Saw head swivels easily to 45 degrees left and 45-60 degrees right and locks for miter cuts
- > Variable blade speed adjusts between 15-90 rpm
- > Accepts saw blades to 350 mm
- > Coolant tank with immersion electric pump improves cooling
- > Stock stop with micrometer adjustment for repetitive parts
- > Manual locking vise with quick lock handle
- > Blade on / off located in trigger handle for greater safety
- > Head tilt pivots on self-lubricating bearings reduces wear
- > Emergency stop with key on control
- > Easy access to emergency stop and two-speed selector
- > Metal base welded for rigid reinforcement
- > Warranty for customer confidence

7.188.02.41 240V
7.188.02.55 480V



CUTTING CAPACITY

	45°	0°	45°	60°
	4"	4"	4"	4"
	3.5"	3.3"	3.5"	2.8"
	4.7" x 2.4"	6.2" x 3.3"	4.7" x 3.3"	3.1" x 2.8"
	1.5 kW			
	15 / 90 rpm			
	6.6"			
	350 mm			
	640 pounds			
	35.5" x 61.2" x 73"			
	37.5"			

TECHNICAL SPECIFICATIONS

Semiautomatic Circular Cold Saw with Pneumatic Vise















MACHINE DESCRIPTION:

Ideal for safe sawing of ferrous or nonferrous tube, pipe and profiles. Pedrazzoli's semiautomatic cold saw improves productivity and cut quality while extending blade life. Saw head down feed and return movements are adjustable with pneumatic controls. Pneumatic vise firmly supports material throughout cut providing burr free parts with less heat transfer. Control panel is conveniently located to operator in front of saw. Patented speed variation ensures quality cuts on a variety of materials. Blade rotation can be reversed for optimum cutting on thin wall tubes. Transmission with pulley system expands rpm range. Worm drive gearbox with clutch to prevent blade breaking during cutting cycle. Proven machine design provides a smooth sawing operation and outstanding reliability. Manufactured and assembled with years of fabrication experience.

Features:

- > Saw head swivels 45 degrees left and 45-60 degrees right for mitering
- > Variable speed blade adjusts between 15-90 rpm
- > Accepts saw blades to 350 mm
- > Coolant tank with easy access for cleaning
- > Complete blade guard coverage with rapid blade system
- > Pneumatic vise available with removable anti burr device
- > Drive pedal for semiautomatic cycle control
- > Head tilt pivots on self-lubricating bearings
- > Electric pump supplies lubrication to key components constantly
- > Anti burr group grips part throughout cutting cycle minimizing burring
- > Easy access to emergency stop and two-speed selector and locking control
- > Stock stop with micrometer adjustment for repetitive parts
- > Metal base welded for rigid reinforcement
- > Warranty for customer confidence
- > Blade cleaning roller inside cover (optional)

7188.22.41 240V
7188.22.55 480V

CUTTING CAPACITY					
	45°	0°	45°	60°	
		4"	4"	4"	4"
		3.5"	3.3"	3.5"	2.8"
		4.7" x 2.4"	6.2" x 3.3"	4.7" x 3.3"	3.1" x 2.8"
	1.5 kW				
	15 / 90 rpm				
	6.6"				
	350 mm				
	662 pounds				
	39.375" x 59" x 59"				
	37.5"				



TECHNICAL SPECIFICATIONS

Semiautomatic Circular Cold Saw with Feeder & Pneumatic Vise

MACHINE DESCRIPTION:













Introducing Pedrazzoli's Super Brown circular cold saw with semi-automatic step feeder. Ideal for any fabrication shop to improve production and reduce labor on multiple cuts. Semi-Auto feature offers safe, quick sawing of ferrous tube, pipe and profiles with minimum clean up. All Pedrazzoli saws feature robust heavy-duty cast iron bases that minimize vibration during the cutting cycle. Work head adjusts to miter left and locks securely in place. Pneumatic vise for faster loading and securing work piece. Anti-burr device adjusts firmly to support material throughout the cut providing burr free parts with no heat transfer. Control panel is conveniently located to operator in front of saw. Pneumatic cylinders with feed regulators control and adjust sawing down feed movement and step feed. Feed system can repeat a maximum of nine steps with total movement to 18 feet. Programmable piece counter is standard. Transmission with pulley system expands rpm range. Worm drive gearbox with clutch to prevent blade breaking during cutting cycle. Proven machine design provides a smooth sawing operation and outstanding reliability. Manufactured and assembled with years of fabrication experience.

Features:

- > Saw head swivels 45 degrees left for mitering
- > Variable speed blade adjusts between 15-90 rpm
- > Accepts saw blades to 350 mm with blade cleaning roller inside cover
- > Coolant tank with electric pump for effective cooling
- > Complete blade guard coverage with rapid blade system
- > Pneumatic vise available with removable anti burr device
- > Head tilt pivots on self-lubricating bearings
- > Gear reverser
- > Electric pump supplies lubrication to key components constantly
- > Anti burr group grips part throughout cutting cycle minimize burring
- > Easy access to emergency stop with lockable switch on control
- > Capacity of feeder collet to six inches
- > Minimum final length six inches
- > Metal base welded for rigid reinforcement
- > Warranty for customer confidence

7.187.32.41 **7.187.32.55**
240V 480V



CUTTING CAPACITY		0°	
		4"	4"
		3.3"	3.5"
		6.2" x 3.3"	4.7" x 3.3"
		1.5 kW	
		15 / 90 rpm	
		6"	
		350 mm	
		926 pounds	
		51.2" x 53.2" x 59"	
	37.5"		

TECHNICAL SPECIFICATIONS

Semiautomatic High-Speed Aluminum Cutting Circular Saw with Pneumatic Vise















MACHINE DESCRIPTION:

Ideal for safe sawing of aluminum, or nonferrous tube, pipe and profiles. Pedrazzoli's semiautomatic cold saw improves productivity and cut quality while extending blade life. High-speed carbide tipped blade for accurate sawing of nonferrous tube and other light alloys. Saw head down feed and return movements are adjustable with pneumatic controls with brake for speed adjustment. Two pneumatic vises adjust lengthwise and laterally to firmly supports material throughout cut providing burr free parts. Control panel is conveniently located to operator in front of saw. Foot Pedal for semiautomatic control of saw cycle. Transmission with pulley system expands rpm range to two blade speeds ensuring quality cuts on a variety of materials. Proven machine design provides a smooth sawing operation and outstanding reliability. Manufactured and assembled with years of fabrication experience.

Features:

- > Saw head swivels 45 degrees left, 45 degrees right and 45 degrees off vertical
- > Two speeds of blade rotation obtainable by inverting pulleys
- > Accepts saw blades to 350 mm
- > Coolant tank with easy access for cleaning
- > Complete blade guard coverage with rapid blade change system
- > Pneumatic vise available with removable anti burr device
- > Drive pedal for semiautomatic cycle control
- > Head tilt pivots on self-lubricating bearings
- > Electric pump supplies lubrication to key components constantly
- > Easy access to emergency stop button
- > Control with lockout switch
- > Stock stop with micrometer adjustment for repetitive parts
- > Metal base welded for rigid reinforcement
- > Warranty for customer confidence

7.105.92.41 240V
7.105.92.55 480V

CUTTING CAPACITY					
	45°	0°	45°	45°	
		3.7"	3.9"	3.7"	2.4" <small>45° off vertical</small>
		3.7"	3.7"	3.5"	2" <small>45° off vertical</small>
		5.1" x 2.2"	6.1" x 2.4"	5.1" x 2.2"	5.9" x 1.6"
	2.2 kW				
	2400 or 3400 rpm				
	6.9"				
	350 mm				
	474 pounds				
	29.5" x 41.3" x 68.9"				
	31.1"				

TECHNICAL SPECIFICATIONS



MATERIAL:

Cold Saw Blades are manufactured from abrasion resistant M2 HSS (High Speed Steel) with a hardness of 60 Rockwell.



BLADE COATING:

All Cold Saw Blades have a coating. The most common is "Steam Oxide" or "Black Oxide" which help the blade hold its edge and prevents galling. Oxide coating has tiny dips and craters that help carry coolant into the cut.

OTHER COATINGS:

High performance coatings, such as a TIN (Titanium Nitride) can increase wear resistance and work well with fine tooth blades.

RUN-OUT:

Typical run-out tolerance for a cold saw blade is 0.01% of the blade's diameter or .001" per diameter inch. Cold Saw Blades are "Hollow Ground", designed to be thicker on the rim gradually tapering to the center "hub" of blade allowing the blade to pass through material and direct coolant into the cut area.

BLADE SHARPENING:

Cold Saw Blades can be resharpened several times. Diameter of the blade is reduced with every sharpening.

PEDRAZZOLI BLADE CONFIGURATION:

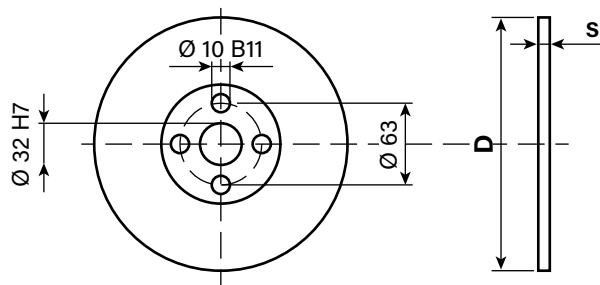

Tooth Geometry, Pitch & Bevel

The following diagrams explain tooth geometry and indicate which blade is appropriate for the size and material to be cut. Once proper pitch is decided, number of teeth for blade can be determined.

COLD SAW BLADE TOOTH GEOMETRY

Tolerance is $\pm 2^\circ$

Proper Tooth Shape

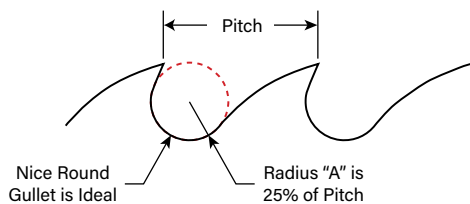

Mild Steel some Low-Alloys

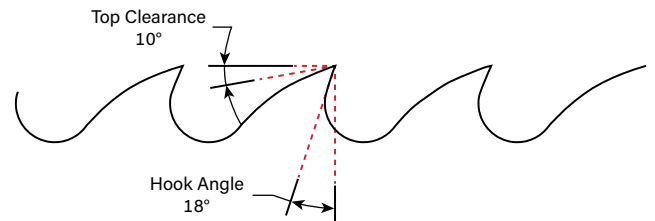

Aluminum, Copper - Non-Ferrous

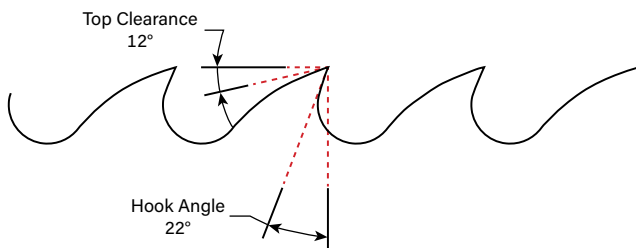

Stainless Steel and some Tool Steels

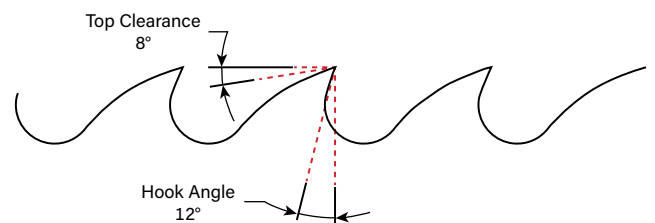

16° - 18° Hook Angle is Standard and is often referred to as "Rake" or "Rake Angle"

COLD SAW PITCH AND BLADE SELECTION

SOLID - Slower RPM & 3-5 Teeth in the Material

Round cuts better with 5 teeth in the material

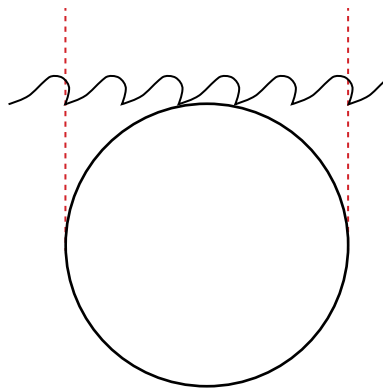

Square cuts better with 3 teeth in the material

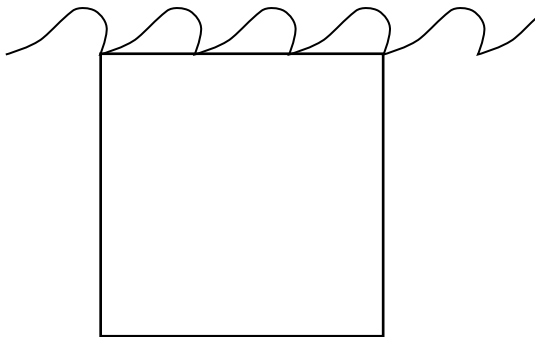

TUBE - Thick Walled

Slower RPM & Pitch should be Less than the Wall Thickness

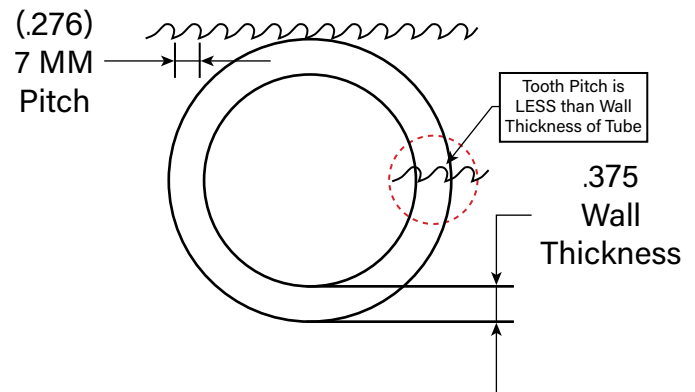

TUBE - Thin Walled

Higher RPM & Pitch should be as small as Practical. 3 - 3.5 mm (.118 - .138) is the Smallest Pitch Available

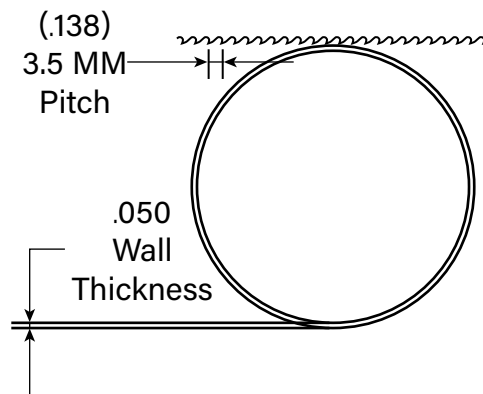

Tooth Geometry, Pitch & Bevel (cont.)

BEVELS, NOTCHES AND APPLICATIONS

ALTERNATE

Teeth are the same Height.
 All Teeth have a Bevel.
 Every Other Tooth is Beveled on Every Other Side. Used on Blades with a 4.5 Pitch or Less. Generally 220 Teeth or more. More Teeth = Smaller Pitch. Used on thinner walled Tube, Angle and Small Solids.

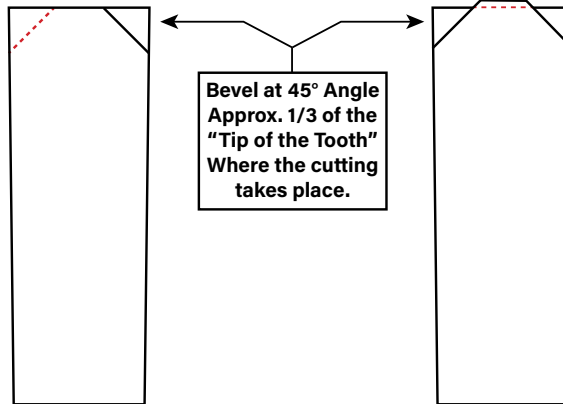

TRIPLE CHIP

Every other Tooth is Taller. Often said to have a "High-Low". The High-Tooth has a Bevel on Both Sides. The Low-Tooth has NO Bevel at all. High-Tooth cuts the middle out and Low-Tooth is the Tooth that leaves Finish on the Cut Part. Generally used on Blades with a 4.5 Pitch or more. Less Teeth = Larger Pitch. Best for Solids and Thick Wall Tube.

NOTCH GRIND

Teeth are the same Height. All Teeth have a Notch. Notches are Offset from Each Other and breaks up the Chip made during the Cut. Typically used on Blades with a 4.5 Pitch or Less. Generally 220 Teeth or more. More Teeth = Smaller Pitch. Best for thinner walled Tube, Blade RPM should be increased.

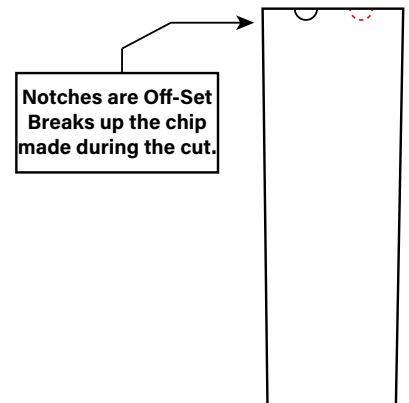

ROUND GRIND

Teeth are the same Height. There is No Bevel. Typically used on Blades with a 3.5 Pitch or Less, as Teeth this small are extremely difficult to bevel. This works best for thinner walled Tube. Also used for soft materials such as Nylon, Plastic, PVC, etc. in most any shape or size and with whatever tooth size works best.

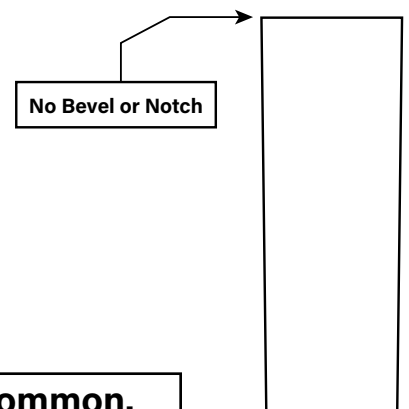

Triple Chip and Alternate Grinds are by far the most common.

SAW BLADE SIZE, NUMBER OF TEETH & PITCH

There is no general purpose or "Universal" Cold Saw Blade. The proper blade must be used for the material being cut.

Pitch is the size of one saw blade tooth, OR distance from one tip to the next in millimeters.

More teeth = a smaller pitch (14" 220 has a 5.0 mm Pitch)

Less teeth = a larger pitch (14" 150 has a 7.5 mm Pitch)

Charts show selection of proper saw blade for material being cut.

Cutting Square Tube across the flat you should increase pitch by 1 mm to 2 mm. For example, Mild Steel 2" round .187" (3/16) wall tube or a 2" square .187" (3/16) tube on the diagonal (point-to-point) with a 14" diameter blade, a 180-tooth blade is used with 6.5 mm pitch.

2" square .187" (3/16") walled tube cut across the flat needs a blade with 7.5 mm to 8.5 mm pitch (less teeth). Chart shows a 14" 150-tooth blade has 7.5 pitch.

Round Tubing - Angle & Square Cut on the Diagonal

Square Tube Cut Across the Flat - Increase Pitch 1 mm - 2 mm (less teeth)

MATERIAL	BLADE SIZE, NO. OF TEETH & PITCH*			
Wall Thickness	275 mm 10¾"	315 mm 12½"	350 mm 14"	Pitch
.030 - .060	260 Teeth	280 Teeth	320 Teeth	3.5 mm
.060 - .090	200 Teeth	220 Teeth	250 Teeth	4.0 mm
.090 - .150	160 Teeth	180 Teeth	200 Teeth	5.5 mm
.150 - .250	For Thick-Walled Tube, Please Call Factory for a Recommendation			
.250 - .375				
.375 - .500				

Solid Round & Square Bar

Tough Alloys or Stainless - Decrease Pitch (more teeth) 1 mm - 2 mm

Aluminum & Copper - Increase Pitch (less teeth) 1 mm - 2 mm

MATERIAL	BLADE SIZE, NO. OF TEETH & PITCH*			
Solid Bar	275 mm 10¾"	315 mm 12½"	350 mm 14"	Pitch
½ in.	200 Teeth	220 Teeth	250 Teeth	3.5 mm
⅝ in.	160 Teeth	180 Teeth	200 Teeth	4.0 mm
¾ in.	140 Teeth	150 Teeth	180 Teeth	5.0 mm
1 in.	120 Teeth	140 Teeth	150 Teeth	6.5 mm
1¼ in.	110 Teeth	120 Teeth	140 Teeth	8.0 mm
1½ in.	100 Teeth	110 Teeth	130 Teeth	8.5 mm
1¾ in.	90 Teeth	100 Teeth	120 Teeth	9.5 mm
2 in.	80 Teeth	90 Teeth	100 Teeth	11 mm

***Ordering information:**

Part numbers: "Blade size-Number of teeth": 275BL-260; 315BL-280; 350BL-320 etc.

PRACTICES TO FOLLOW

CLEAN SPINDLE AND FLANGE

When metal chips are allowed between Flange and/or spindle during mounting, saw blade may “wobble”, have excessive run-out or contribute to other saw blade problems like pick-up.

REMOVE BACKLASH

The saw blade is driven by pins in the flange. When changing blades, backlash must be removed or “taken-up”. When blade is placed on machine, and before bolt on flange is tightened, lift up on front of blade and hold it until bolt is tight. This keeps blade against pins in the flange. If blade breaks through pin-hole, backlash was not removed.



TROUBLESHOOTING

BLADE PICK-UP

Dull blade, improper coolant, wrong blade, incorrect rpm or too much down-pressure contributes to pick-up.

Pick-up occurs when material being cut bonds itself to both sides of blade teeth making them wider. This may cause the saw head to jump or vibrate during the cut. Saw blade may seem “out-of-round” during the cut. Pick-up will jam blade into material and lead to damaged blades or material moving during the cut. This may force blade to one side, and shatter it. If there is pick-up on the blade **STOP** using and replace. Resharpen blade to avoid pick-up.

MATERIAL SLIPPING IN VISE

Material must be properly seated and solidly clamped in vise. If material moves during cut it can bend or break saw blade. Unusual rub marks on one side of blade indicate slippage.

PROLONG SAW BLADE LIFE

BREAKING IN BLADE

New or resharpened blades have sharp edges. Feed blade slowly through material for the first 3-4 cuts.

COOLANT

Use water soluble base coolant mixed to proper strength. Rust indicates weak coolant. Weak coolant will shorten blade life and contribute to pick-up.

SAW BLADE DIAMETER

Small blades are the more rigid. SFM (Surface Feet per Minute) or “Rim Speed” is less with a smaller blade. Smaller blades are less expensive to purchase and sharpen.













MACHINE DESCRIPTION:

Introducing the Brown SN300 band saw with gravity controlled down feed from Pedrazzoli. All saws are not created equal, learn how Pedrazzoli leads the industry in design and dependability. Stable saw platforms increase productivity, improve blade life and overall cut quality and squareness. All Pedrazzoli saws feature robust heavy-duty cast iron bases that minimize vibration during the cutting cycle. The large diameter miter base glides easily over tempered bearing track for easy smooth rotation of saw head. Vise shoulders retract and adjust to support to material effectively for more consistently to the profile being cut. Down gravity feed control is balanced with Pedrazzoli's dynamic feed mode. Saw motor mounts vertically reducing overall dimensions of transmission to worm gear drive with full oil bath for longer component life and less maintenance.

Features:

- > Saw positions 60 degrees left and 45 degrees right to fixed stops
- > Large circular saw base rotates over ball track for easy miter movement
- > Saw bow movement supported with conical bearings
- > Two blade speed selections for greater material versatility
- > Control panel with simple operator control functions
- > Blade drive safety switch located in hand grip
- > Safety micro-switch prevents blade operation when guard is open
- > Blade tensioning handwheel with spring for uniform tensioning
- > Blade guide arms adjustable to dimension of workpiece
- > Blade guides feature two hardened guides on eccentric bushings
- > Vise shoulders adjust and retract
- > Coolant reservoir with removable electric pump for easy cleaning
- > Heavy cast iron saw base for greater rigidity when sawing
- > Machine on off switch with lockout switch
- > Length stop with micrometer adjustment
- > Machine base designed to accommodate fork lift

7.193.34.41 **7.193.34.55**
240V 480V

CUTTING CAPACITY					
		45°	0°	45°	60°
		6.3"	8.7"	7.9"	5.1"
		4.7"	7.5"	5.9"	4.3"
		6.3" x 5.1"	13" x 5.9"	4.7" x 5.1"	4.3" x 4.3"
		1.25 / 1.75 kW			
		35 / 70 m/1*			
		360 mm			
		111.2" x 1.0625" x .032"			
		950 lb			
	56" x 60" x 71" *including length stop				

TECHNICAL SPECIFICATIONS

Down feed Mode Selection for Newton models

Manual mode: From control panel select M position (manual). Rotate hand wheel of tension spring to align 0 (zero) on scale tightening balance spring. Secure material in vise, press the start button to activate manual cutting cycle. Adjust bow descent pressure with flow regulator.

Dynamic mode: From control panel select D position (dynamic). Rotate handwheel of tension spring to 40 (forty) on scale loosening balance spring. Adjust limit switch at end of cutting cycle. Secure material in vise, position blade above material to be cut and press the start button. Bow descent pressure is controlled by gravity. At the end of cut limit switch will stop blade motion. Raise bow above workpiece.

Available Accessories

- > Material roller table for loading work-piece



Semiautomatic Band Saw Variable Speed Control

MACHINE DESCRIPTION:

Introducing the Brown SN 420 SA semiautomatic band saw from Pedrazzoli. All saws are not created equal, learn how Pedrazzoli leads the industry in design and dependability. Stable saw platforms increase productivity, improve blade life and overall cut quality and squareness. Ideal for sawing of ferrous or nonferrous tube, pipe and profiles. All Pedrazzoli saws feature robust heavy-duty cast iron bases that minimize vibration during the cutting cycle. Machine can be operated manually or in semiautomatic cycle control of bow movement with flow regulator to adjust downward speed. Bow returns to start position while vise remains closed. The large diameter miter base glides easily over tempered bearing track for easy smooth rotation of saw head. Vise shoulders retract and adjust to support to material effectively for more consistently to the profile being cut. Saw motor mounts vertically reducing overall dimensions of transmission to worm gear drive with full oil bath for longer component life and less maintenance. Proven machine design provides a smooth sawing operation and outstanding reliability. Manufactured and assembled with years of fabrication experience.

Features:















- > Saw positions 60 degrees left and 45 degrees right to fixed stops
- > Large circular saw base rotates over ball track for easy miter movement
- > Variable blade speed adjustment for better sawing performance
- > Laser indicator for aligning cutting position
- > Saw bow movement supported with conical bearings
- > Two blade speed selections for greater material versatility
- > Control panel with simple operator control functions
- > Foot pedal for semiautomatic cutting cycle
- > Blade drive safety switch located in hand grip
- > Safety micro-switch prevents blade operation when guard is open
- > Electronic safety sensor stops band motion in case of breakage
- > Blade tensioning handwheel with spring for uniform tensioning
- > Blade guide arms adjustable to dimension of workpiece
- > Blade guides feature two hardened guides on eccentric bushings
- > Vise shoulders adjust and retract
- > Coolant reservoir with removable electric pump for easy cleaning
- > Heavy cast iron saw base for greater rigidity when sawing
- > Machine on off switch with lockout switch
- > Length stop with micrometer adjustment
- > Machine base designed to accommodate fork lift

Available Accessories

- > Material roller table for loading work piece

7.197.43.41 7.197.43.55
240V 480V

CUTTING CAPACITY

	 45°	 0°	 45°	 60°
	6.7"	11"	9.1"	5.9"
	5.9"	10.6"	8.7"	5.9"
	9.4" x 3.5"	16.5" x 7.5"	9.1" x 5.9"	3.1" x 2.8"
	1.6 / 2.0 kW			
	35 / 70 m/1* Variable			
	16.5"			
	124" x 1.0625" x .035"			
	1342 lb			
	56" x 74" x 83" *including length stop			
	37.5"			

TECHNICAL SPECIFICATIONS



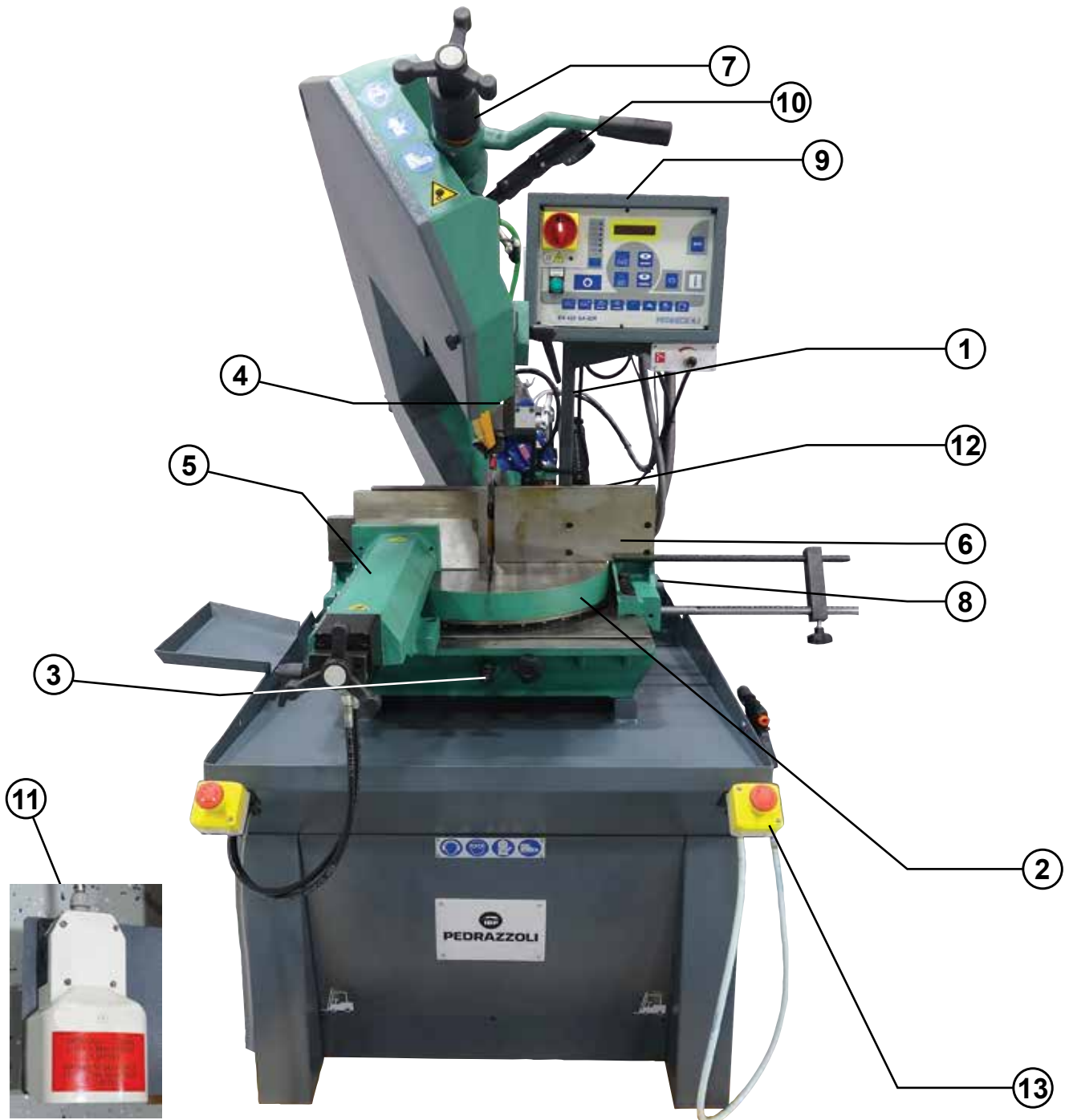

GENERAL IDENTIFICATION OF PARTS

- | | |
|---|--|
| 1. Transmission by means of reducer | 8. Lubrication cooling pump |
| 2. Large support table rotating together with blade | 9. Control panel |
| 3. Pin for 90° cuts | 10. Momentary trigger switch for blade drive |
| 4. Blade guides | 11. Start pedal |
| 5. Adjustable semiautomatic hydraulic vise | 12. Bow support by conical bearings |
| 6. Adjustable and retractable vise shoulders | 13. Double emergency push button |
| 7. Blade tightening device | 14. Electronic safety sensor (under guard) |

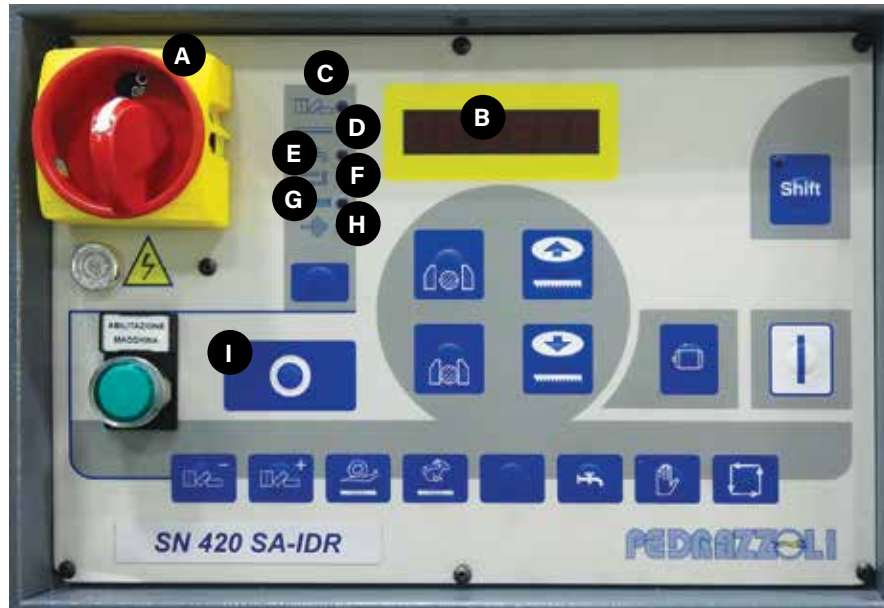

SA-IDR CONTROL PANEL

PLC control panel specifically developed for Pedrazzoli band saws: it can be programmed by the operator according to the machine use requirements. The machine can work in manual or semiautomatic mode.

- A. ON/OFF switch
- B. Digital display
- C. Programmable piece counter
- D. Blade rotation speed
- E. Lubrication
- F. Manual or semiautomatic cycle selection
- G. Advanced functions (vise opening/closing at the end of cutting - ON/OFF blade rotation at the end of cutting - etc.)
- H. Ampere absorption display (for cutting speed control, blade wear, etc.)
- I. Semiautomatic cycle stop (acting on this key the bow goes up & the vise stays closed)
- J. Flow regulator, for adjusting bow descent speed



Hydraulic cylinder for bow movement



Laser pointer for cutting position



Gear reduction drive



Large circular table rotating together with the bow to ensure optimal support of the piece to be cut.



Carbide blade guides



Adjustable carbide blade guides









Vise with quick approach, can be positioned transversally along the entire machine base. Adjustable vise shoulders.

BAND SAW BLADE DIMENSIONS FOR PEDRAZZOLI SAWS

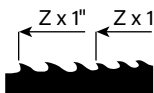
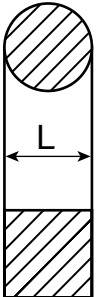
	LENGTH	WIDTH	THICKNESS
SN300 BAND SAW	111.2"	1.062"	.035"
SN420 BAND SAW	124"	1.062"	.035"

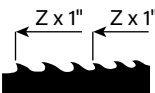
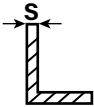
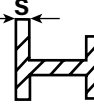
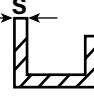
BAND SAW BLADE SELECTION

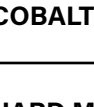
	S inches				L inches				
	< .060	14	-----		< 1½	8	6/10		
	< .158 - .316	10	10/14		< 1½ - 3⅞	6	5/8		
	> .083 - .158	8	8/12		< 2⅞ - 3½	4	4/6		
	> .158 - .316	6	6/10		> 4	3	3/4		
	> .141 - .282	6	5/8		Reduced speed for stainless steel and large sections			Emulsion	7+10%
	> .282	4	4/6			Emulsion			

TYPICAL BLADE MATERIALS

BIMETAL	- Interrupted cuts; structural steel; tubes and broken blade teeth.
COBALT M42	- Automatic saws and machines for production, hard metal, stainless steel.
HARD METAL H.M.	- Hardened special bronze, AMPCO, material COBALT M43 has difficulty cutting.
ONEMETAL/SL	- General and occasional use; with low tool cost.
ONEMETAL/SR	- Efficient higher cutting with production, without offering high production.
COBALT/51	- Hard material with automatic machine cycle with rigid structure teeth.

Semiautomatic Circular Upcut Saw

MACHINE DESCRIPTION:

Semiautomatic circular cold saw with hydraulically fed upcut blade movement designed to quickly and accurately produce straight and miter cuts in a wide range of profile and solid materials. Workpiece is cut from the center of the table and material is held firmly with vertical hydraulic clamping throughout the cut providing burr free parts with minimum heat transfer. Machine accepts circular saw blade to 450 mm with capacity to 6-inch round profiles when cut at 90 degrees. Blade is driven by precision ground and hardened helical gears providing consistent cutting speed for tube and solid materials. Rotational speed of the blade is variable and adjusts with inverter from machine control panel to accommodate a variety of materials. Proven machine design provides a smooth sawing operation and outstanding reliability. Manufactured and assembled with years of fabrication experience.















Features:

- > Table adjusts 0-170 degrees with three stops and locks
- > Heavy-duty precision gear box with variable blade RPM through inverter drive
- > Self balancing valve for smooth forward movement of blade
- > Digital adjustment of blade stroke
- > RPM 13 to 77 or 24-144 depending on model
- > Accepts saw blades to 450 mm
- > Coolant system to extend blade life
- > Adjustable vertical clamping of material
- > Saw angle adjusts inside of table base via hand wheel for miter cutting
- > Heavy-duty metal base welded for rigid reinforcement
- > Optional in-feed and exit support tables with stock stop for sawing repetitive parts

7.177.08.41 **7.177.08.55**
240V 480V

CUTTING CAPACITY

	 45°	 0°	 45°	 60°
	5.9"	5.9"	5.9"	5.5"
	4.7"	5.1"	4.7"	4.3"
	4.0 kW			
	13-77 / 24-144 rpm (specify when ordering)			
	6.9"			
	450 mm			
	2,600 pounds			
	55" x 69" x 70"			
	42"			

TECHNICAL SPECIFICATIONS





Adjustable clamp and feed pressure



Touch screen control



Incoming power transformer



Pivot/Miter Table

Semiautomatic Circular Upcut Saw

CAPACITY CHART IN INCHES

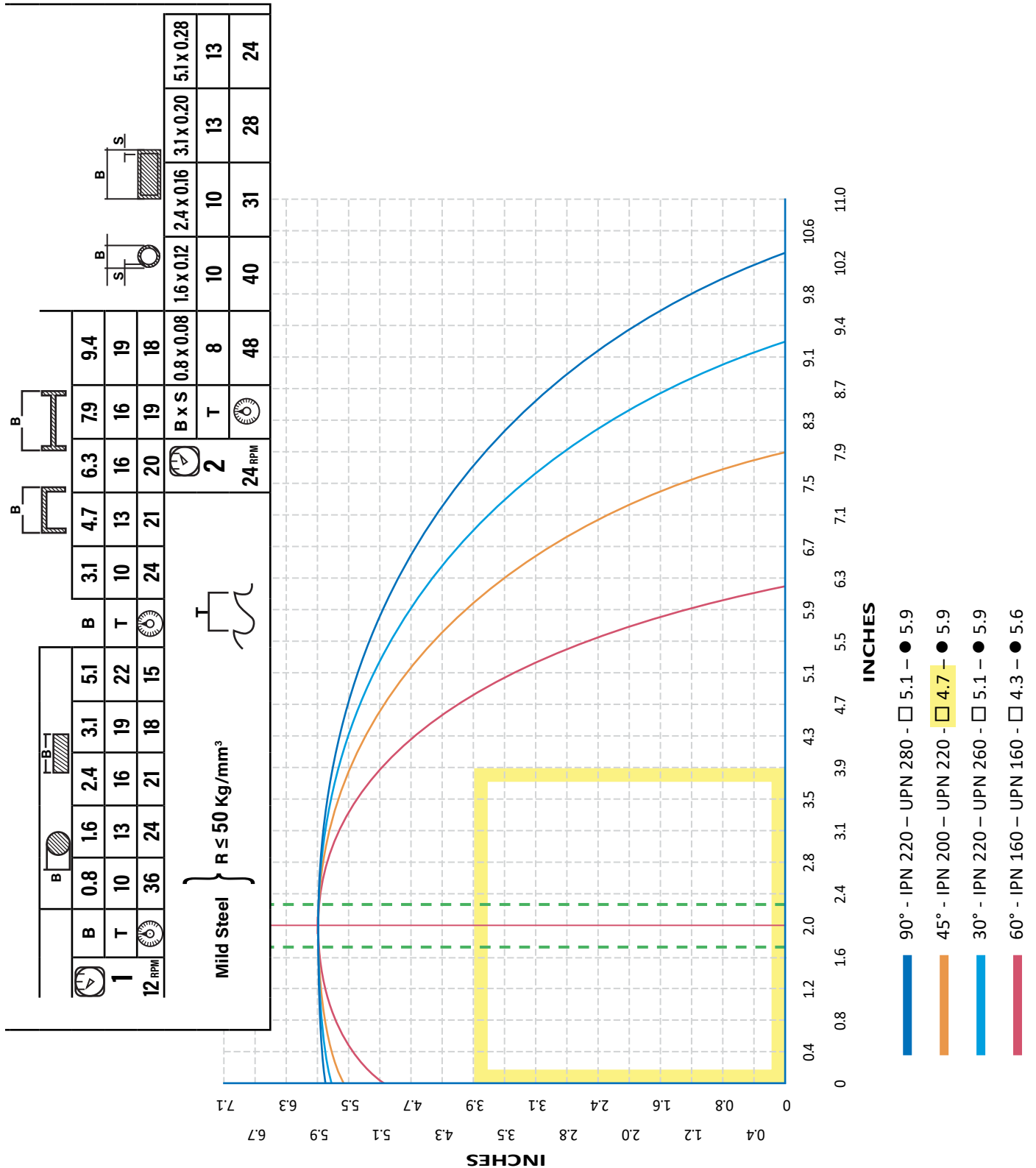

Semiautomatic Circular Upcut Saw

OPTIMAL RPM FOR 450 MM HSS BLADE

It is important to dial in RPM for best performance and blade life

Running cold saw blade at too low RPM will cause poor cut quality, tooth breakage, and lower production.

Running cold saw blade too fast will dull the blade prematurely.

Variable speed machines dial in the RPM exactly. Two speed machines select speed closest to recommended RPM.

RECOMMENDED SFM & RPM FOR 450 MM HSS BLADE*

Material Type & Shape	SFM	RPM
Mild Steel - Solids & Thick Walled Pipe	90 - 125	20 - 27
Mild Steel - Thin Wall Tubing (0.062" or less)	140 - 185	27 - 40
Stainless Steel - Solids & Thick Walled Pipe	50 - 90	11 - 20
Stainless Steel - Thin Wall Tubing (0.062" or less)	85 - 130	18 - 28
Non-Ferrous - Aluminum, Brass, Copper	225 - 360	49 - 76

RECOMMENDED NUMBER OF TEETH BASED ON APPLICATION SHAPE/SIZE*

Square Tube Cut Flat					
Wall Thickness	Width				
	1"	1.5"	2"	3"	4"
0.062	360	320	280	260	240
0.093	340	280	240	200	200
0.125	300	260	220	200	180
0.187		240	200	180	160
0.250			180	160	150
0.312			160	150	140
0.375				140	120

Steel Round Tube							
Wall Thickness	Diameter						
	1"	1.5"	2"	3"	4"	5"	6"
0.062	440	400	380	380	380		
0.093	400	380	340	320	320		
0.125	360	340	300	280	280	280	
0.187		300	280	260	240	240	240
0.250			220	200	200	200	200
0.312				180	180	180	180
0.375				160	160	160	150
0.500				160	150	140	130

Solid	#	Solid	#
1/8"	520	1-1/2"	180
1/4"	400	1-3/4"	160
3/8"	360	2"	150
1/2"	300	2-1/4"	140
5/8"	280	2-1/2"	130
3/4"	240	3"	120
1"	220	3-1/2"	110
1-1/4"	200	4"	100

Angle	#
1/16"	520
1/8"	440
3/16"	360
1/4"	320
3/8"	280
1/2"	220
3/4"	180

When cutting angle iron, position elbow upward to avoid blade breakage!

*Ordering information:

Part numbers: "Blade size-Number of teeth": 450BL-360; 450BL-320; 450BL-280 etc.



Application Review



Demonstration / Training Facility

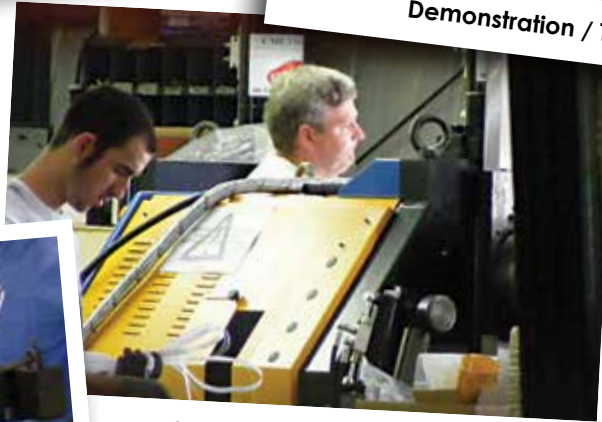

Service After the Sale



Hands-on Training



Quality Repeatable Bends

Taking Care of Bending



About This Catalog:

We have tried to make this catalog comprehensive and factual. CML USA, Inc. reserves the right to make changes at any time without notice to price, color, material, equipment, specifications, models, machine operation, tooling requirements and availability. Catalog may have been updated since the time of printing.

info@ercolina-usa.com



Call TODAY for a quote!
Leasing Options Available



PEDRAZZOLI



CML USA, Inc.

“ Excellence in Quality, Support and Service ”

3100 Research Parkway • Davenport, IA 52806
Ph. 563-391-7700 • info@ercolina-usa.com

www.ercolina-usa.com

www.pedrazzoli-usa.com